

# AnatoliaLED®

LED LIGHTING TECHNOLOGY

**DEKORATİF ALÜMİNYUM AYDINLATMA DİREKLERİ**

DECORATIVE ALUMINIUM LIGHTING POLES

*Her fikir ilginç olmak zorunda değildir ama özgün olmak zorundadır.*

  
GRUP **HAKÖZ**®  
mühendislik & elektroteknik



ÜRÜN KATALOĞU  
**PRODUCT CATALOG**

*Şirket Profilimiz*

## Kurumsal

Daha öncesinde içinde bulunduğumuz aydınlatma sektöründe birçok başarılı projeye imza attık. 2015 yılı itibari ile alüminyum direk imalatına başlayıp kendi tasarımlarımız olan aydınlatma direkleri ile piyasaya farklı bir bakış açısı getirmiş bulunmaktayız.

Enerji tasarrufu ve yenilenebilir maddelere ihtiyacımızın arttığı günümüzde, alüminyumun uzun ömürlü ve geri dönüştürebilir olması; led ışık kaynağının ise diğer ışık kaynaklarına oranla çok daha fazla tasarruf sağlaması aydınlatma direklerinde bu iki materyali birleştirmemizin en önemli sebebi oldu.

## Vizyonumuz

Uluslararası vizyon, misyon ve değerleri doğrultusunda çalışmak, müşteri isteklerinin daima ön planda tutulması, çevreye, doğaya ve topluma saygı, İnsan kaynaklarına değer veren, üretkenliği destekleyen ve gelişmesine yardımcı olan açık iletişime dayalı çağdaş yönetim anlayışı, tüm kaynakların verimli kullanımı, müşterilerimiz, ortaklarımız, tedarikçilerimiz ve çalışanlarımızla bütünlük duygusu, ticari ve sosyal ilişkilerimizde karşılıklı güven, üstün iş ahlakı ve dürüst davranış ilkesinden vazgeçmemek olacaktır.

## Kalite Politikamız

İç ve dış müşterilerin memnuniyetini sürekli artırarak tercih edilebilirliğimizi sürdürülebilir kılmak. Müşteri için gereken ürün ve hizmet kalitesini minimum maliyet ile sağlamak için süreçlerin sürekli gözden geçirerek iyileştirilmesini sağlamak. Çevreye dost, geri dönüşebilir bir malzeme olan alüminyumun kullanımını sağlamak.

Özel olarak tasarlanmış geniş ürün yelpazesini müşterilerimize sunmak. Korozyona ve dış hava şartlarına karşı sağlam üretim. Uzun kullanım ömrü ve farklı renklerde görselleği artırmak. Yüksek yansıtma kabiliyeti ile estetik ve şık görünüm.

## Misyonumuz

Gerçekleştirmek istenen projenin kaynaklarımıza göre değerlendirilip etkin ve verimli kullanımıyla, en az maliyette rekabet edebilir kalitede üretim ve hizmet sağlayarak müşterilerimizin ve diğer tüm paydaşlarımızın memnuniyetini kalite politikamızdan ödün vermeden sağlamak.



*Company Profile*

## Corporate

We have been carried out a lot of successful projects and become one of the most respected firms in lighting market. In 2015 we have started aluminum pole production and brought a different perspective to the market with our own designs and lighting poles.

Today, necessity of energy saving and renewable materials is increasing, aluminum is long lasting and recyclable, the most important reason why we combine these two materials in the light poles is that the led light source can save much more energy than other light sources.

## Our Vision

We work in the direction of international vision, goal and values, to keep our customers' requests always on top, to respect for the environment, nature and collective respect, to respect human resources, to support productivity and to help develop our modern communication management approach, efficient use of all resources. We will not give up our principles of mutual trust, superior business ethics and honest behavior in our commercial and social relations with our suppliers and employees.

## Quality Policy

To increase the satisfaction of the domestic and international customers and to make our preference sustainable. To ensure that the processes are constantly improved by ensuring the quality of the products and services demanded by the customer with minimum cost. Provide the use of aluminium, which is recyclable and nature friendly.

To offer our customers a wide range of specially designed products. Robust production against corrosion and weather conditions. Long lifetime and increase visuals in different colors. Aesthetic and stylish appearance with high reflection ability.

## Our Goal

To ensure the satisfaction of our customers and all other stakeholders without compromising our quality policy by providing efficient and efficient use of the project according to our sources and providing production and service at competitive prices with the least cost.



*Personel İletişim  
Adreslerimiz  
Staff Contact  
Address*

## Özgür KÖSE

Genel Müdür / General Manager  
ozgur.kose@hako.com.tr

## İsa DURGUN

Genel Koordinatör  
General Coordinator  
isa.durgun@hako.com.tr

## Ümit ÖZTÜRK

Teknik Koordinatör  
Technical Coordinator  
umit.ozturk@hako.com.tr

## Tarık KORKMAZ

Tasarım Uzmanı  
Design Specialist  
tarik.korkmaz@hako.com.tr

## Özcan KÖSE

Mekanik Formen  
Mechanical Foreman  
info@hako.com.tr

## Muhammed AKSU

Elektrik Mühendisi  
Electric Engineer  
muhammed@hako.com.tr

## Teoman ÇAĞATAY

Satış – Pazarlama Müdürü  
Sales – Marketing Manager  
teoman@hako.com.tr

## Adnan GÖKBAYRAK

Satın Alma Uzmanı  
Purchasing Specialist  
adnan@hako.com.tr

## Orkun DİNÇ

Muhasebe Sorumlusu  
Accounting Supervisor  
muhasabe@hako.com.tr

## Fatih BALCI

Mali İşler Müdürü  
Financial Affairs Manager  
fatih@hako.com.tr

A decorative background pattern consisting of a grid of diamond shapes (rhombuses) formed by thin black lines. The diamonds are arranged in a staggered, overlapping fashion, creating a mesh-like structure. The lines are thin and black, set against a plain white background.

*Şirket  
Referanslarımız*

*Company  
References*





*Çözüm  
Ortaklarımız  
Solution  
Partners*

**CREE**   
LEDs

LED  Light for you

**OSRAM**

**PHILIPS**

**TRIDONIC**  
DISTRIBUTION UK

**MW**  
MEAN WELL

GENUINE  
NICHIA  
LED  <sup>®</sup>

Samsung  
 Lighting



*Belgelerimiz*  
*Documents*

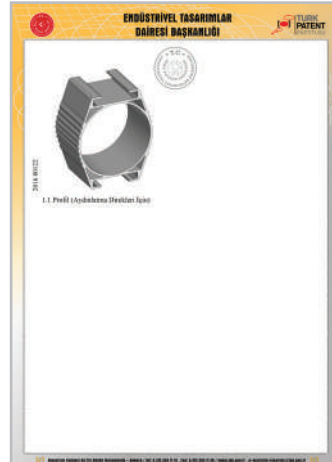
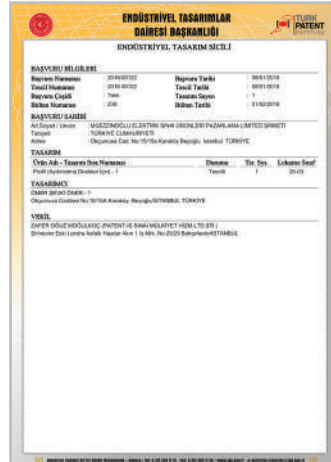

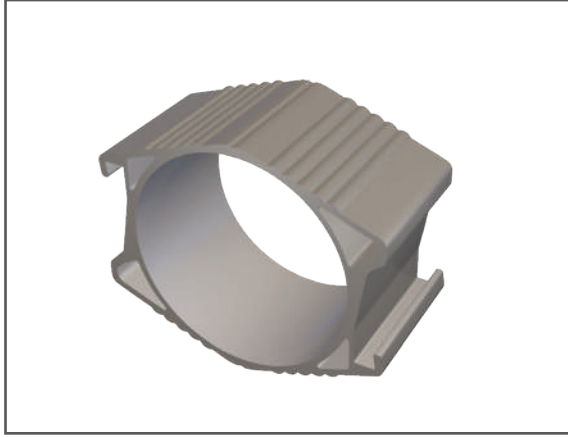

## Malzemelere Ait Teknik Özellikler

- Uluslararası EN 60958 standartlarına göre veya benzeri Avrupa standartlarında üretilmiş ve test edilmiş malzeme kullanılır.
- TANIMLAR:
- Ekstrüzyon: Malzemelere sıcak ve soğuk halde basınç altında sürekli (sürekli) plastik şekil verme prosesidir.
- Alüminyum Profil: Ekstrüzyon prosesiyle elde edilen alüminyum alaşımlı mamüldür.
- Ekstrüzyon Oranı: Kalıba giren hammadde alanının çıkan toplam ürün alanına oranıdır.
- Eloksal: Alüminyum profillerin yüzeyini elektroliz yöntemi ile anodik oksidasyona tabi tutarak korozyona ve dış etkilere karşı dayanıklı hale getirmek ve dekoratif bir görünüm kazandırmak için yapılan yüzey işlemi.
- Boya uygulamaları için doğru boya bileşenleri ve tinerlerinin kullanılmasına dikkat edilir. Boya uygulayıcı personelimiz tecrübeli ve teknik spesifikasyon bilgilerine sahiptir.

## Kullanılan Alüminyumun Kimyasal Bileşimi

İmalatta kullanılacak alüminyum hammadde alaşımı EN-AW 6060 olup, alaşımlama elemanları aşağıda belirtilen limitler içindedir.

ELEMENT	Si	Fe	Cu	Mn	Mg	Cr	Zn	Ti	Diğer Her Biri	Diğer Toplam	Al
MIN	0,41	0,17			0,44						
MAX	0,46	0,22	0,02	0,05	0,48	0,02	0,02	0,02	0,05	0,15	Kalan

## Alüminyum Profillerin Üretimi ( Ekstrüzyon Prosesi ) ve Özellikleri Profillerin Ölçü Toleransları ve Yüzey Özellikleri

- Kullanılan profilin ölçü ve toleransları, EN 755-9'a uygun değerlerdedir.
- Profillerin görünür yüzeylerinde kalıp çizgisi, yırtık pick-up, çapak olmaz ve görünür yüzeyler eloksal kalitesindedir.

## Profillerin Mekanik Özellikleri

- EN AW - 6060 alaşımlı söz konusu profiller, T66 temper özelliklerini sağlayacak şekilde suni yaşlandırma ısıl işlemine tabi tutulur ve profillerin mekanik özellikleri TS-EN 755-2'ye uygundur.
- TS EN 7552 Standartına göre bu profillerin;  
Akma Mukavemeti: ( Rp0,2 ) min. 160 Mpa, Çekme Mukavemeti: ( Rm ) min. 215 Mpa % uzaması: ( A50mm ) ise %6, değerlerindedir.

## Profillerin Kaynak İşlemi

- Profillerin kaynak işlemi DIN EN 287-2 standartlarına uygun yapılır.
- Kaynak ve benzeri işlemler için personele özellikleri (personel uygulanacak olan test prosedürü, kaynak projesi ve kaynak şekilleri yapılan kaynak testi parçasının değerlendirilmesi) standardına uygun olarak, TÜV Cert tarafından sınanmış ve sertifikalandırılmış kaynakçılar tarafından yapılmaktadır.

## Profillerin Bükme İşlemi

Kullanılacak profillerin büküm işlemi " dijital radius ölçü kontrollü CNC büküm makinesi " ile yapılmaktadır.

## Profillerin Eloksal İşlemi

- Eloksal yüzey işlemini gerçekleştirecek tesisin TS 4992 " Metalik Malzemelerin Yüzey İşlemi - Alüminyum ve biçimlendirilebilir Alüminyum Alaşımlarının Anodik Oksidasyonu (eloksal) Teknik Özellikler " Türk standartlarına uygunluk belgesine ve sertifikasına uygundur.
- Eloksal işlemi büküm ve mekanik işlemlerden sonra uygulanmaktadır.

## Eloksal Yüzey Kaplama Özellikleri

- Eloksal yüzey kaplama kalınlığı min. 10 mikron olarak gerçekleşir. Ölçüm işleminde kullanılan " isoscope (eloksal kaplama kalınlığı ölçüm cihazı) DIN EN ISO 2360: Manyetik Olmayan Metaller Üzerindeki Yalıtkan kaplamalar - kaplama kalınlığı ölçümü - Girdap akımı metodu" standartına uygundur.

## Dayanım ve Işık İşlem Özellikleri ( EN AW 6063 ( AlMg0,7Si) için)

- Ekstrüzyonla İmal Edilmiş Boru

TEMPER	ET KALINLIĞI	RM (ÇEKME)	RP 0.2 (AKMA)	A % (UZAMA)	A(50) % UZAMA
T4	e<15 mm	120	60	16	14
T5	e<15 mm	260	120	8	6
T66	e<15 mm	215	160	8	6

TEMPER	ET KALINLIĞI	RM (ÇEKME)	RP 0.2 (AKMA)	A % (UZAMA)	A(50) % UZAMA
T4	e<15 mm	120	60	16	14
T5	5mm<e<25mm	140	100	8	6
T66	3mm<e<15mm	195	150	8	6

T4 Temper: 520C'de 1 saat ısıtılıp solüsyona alınarak elde edilir.

T4 Temper ısıtım seviyesidir. Daha sonra 182C'de 3 saat bekletilerek T5 temper elde edilir.

T66 Temperin elde edilmesi için T4 temper elde edildikten sonra 177C'de 8 saat bekletilir. T5 ve sonrası temperler yapay yaşlandırma olarak bilinirler. Malzemenin sertlik ve dayanımı arttırmaya yönelik işlemlerdir.

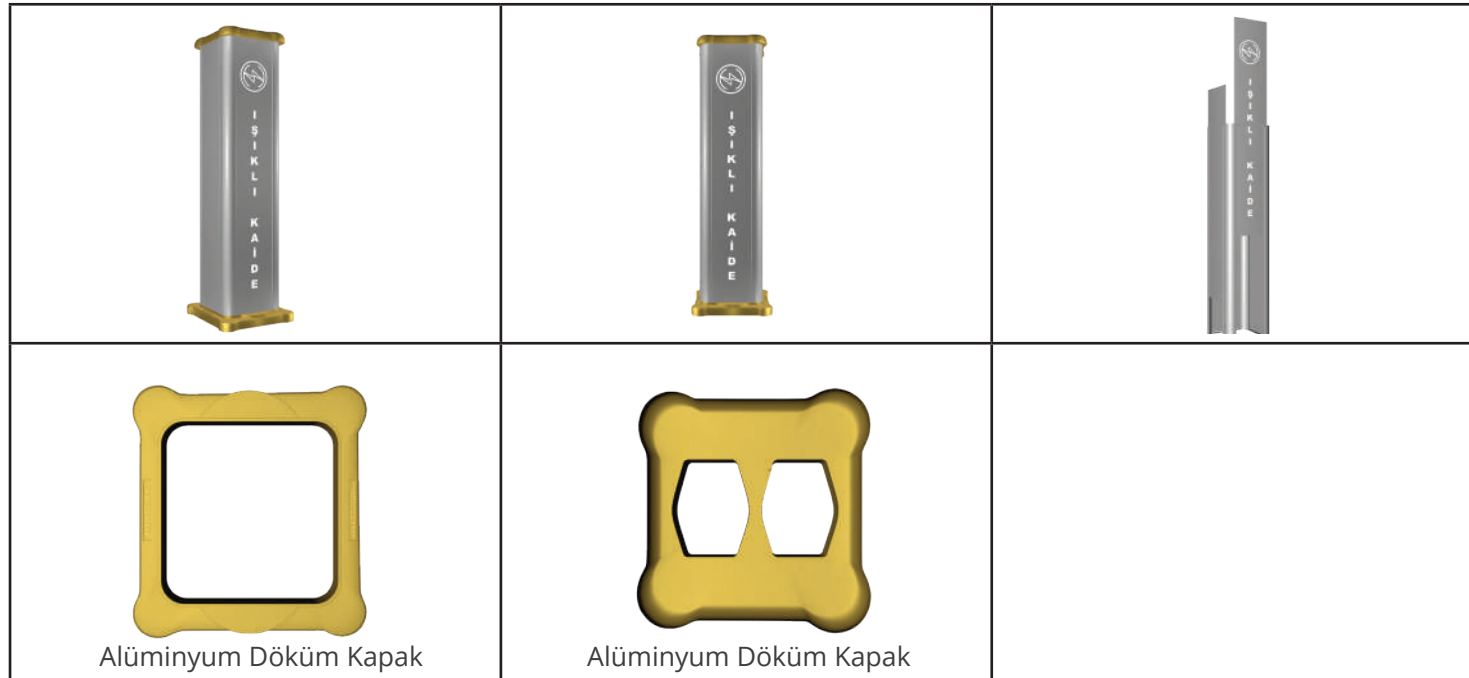

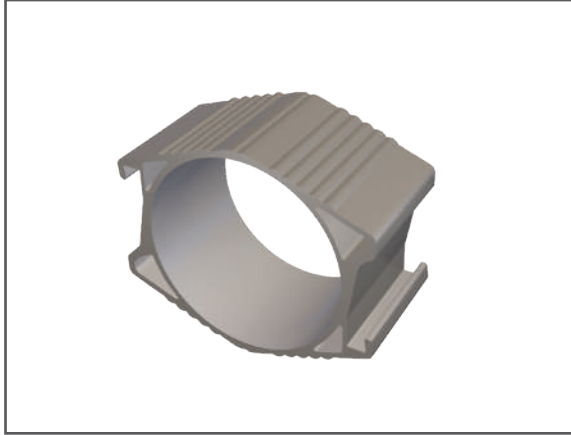

## Material Specifications

- Materials that manufactured and tested according to international EN 60958 standards or similar European standards are used.
- DEFINITIONS:
- Extrusion : The material is in a continuous plastic forming process under pressure in hot and cold conditions.
- Aluminium Profile: It is an aluminium alloy product obtained by extrusion process.
- Extrusion Ratio: It is the ratio of the raw material area entering the casting to the leaving total product area.
- Eloxal: Surface treatment to make the surface of aluminium profiles resistant to corrosion and external influences by subjecting to anodic oxidation by electrolysis method and to give a decorative appearance.
- Our paint application staff pays extra attention to the use of correct paint components and thinners for paint applications and have experience and technical specific information.

## Chemical Composition of Used Aluminium

The aluminum raw material alloy to be used in manufacturing is EN-AW 6060 and the alloying elements are within the following limits.

ELEMENT	Si	Fe	Cu	Mn	Mg	Cr	Zn	Ti	Other All	Other Total	Al
MIN	0,41	0,17			0,44						
MAX	0,46	0,22	0,02	0,05	0,48	0,02	0,02	0,02	0,05	0,15	Kalan

## Production of Aluminum Profiles (Extrusion Process) and Properties Profiles Measurement Tolerances and Surface Properties

- The dimensions and tolerances of the profile used are in accordance with EN 755-9.
- On the visible surfaces of the profiles, there are no stripes, torn pick-ups, burrs, and visible surfaces are in eloxal quality.

## Mechanical Properties of Profiles

- The EN AW - 6060 alloys are subjected to artificial aging heat treatment to provide T66 temper properties and the mechanical properties of the profiles are in accordance with TS - EN 755-2.
  - According to TS EN 7552 Standard;
- Flow Strength: (Rp0,2) min. 160 MPa, Tensile Strength: (Rm) min. 215 MPa% elongation: (A50mm) is at 6%.

## Welding of Profiles

- Welding of the profiles is done in accordance with DIN EN 287-2 standards.
- Personnel spesification for welding and similar operations are made by welders who have been tested and certified by TÜV Cert in accordance with the standard (staff test procedure, welding project and welding form evaluation of welding test piece).

## Process of Bending the Profiles

The bending process of the profiles to be used is done with " CNC bending machine with digital radius measurement control ".

## Eloxal Processing of Profiles

- Plant that will provide eloxal Surface Treatment TS 4992 'Surface Treatment of Metallic Materials – Aluminum, Anodic Oxidation of Aluminum and Formable Aluminum Alloys' Technical Specifications " is suitable for the certificate and certificate of conformity to Turkish standards.
- Anodising is applied after bending and mechanical operations.

## Eloxal Surface Coating Properties

- Eloxal surface coating thickness min. 10 microns. The " isoscope (eloxal layer thickness meter) used in the measurement process is in accordance with DIN EN ISO 2360: Insulating coatings on non-magnetic metals - coating thickness measurement - eddy current method " standard.

## Strength and Light Processing Properties (for EN AW 6063 (AlMg0,7Si))

- Pipe that is produced by extrusion

TEMPER	WALL THICKNESS	RM (TENSILE)	RP 0.2 (YIELD)	A % (ELONGATION)	A(50) % ELONGATION
T4	e<15 mm	120	60	16	14
T5	e<15 mm	260	120	8	6
T66	e<15 mm	215	160	8	6

TEMPER	WALL THICKNESS	RM (TENSILE)	RP 0.2 (YIELD)	A % (ELONGATION)	A(50) % ELONGATION
T4	e<15 mm	120	60	16	14
T5	5mm<e<25mm	140	100	8	6
T66	3mm<e<15mm	195	150	8	6

T4 Temper: It is obtained by heating at 520 ° C for 1 hour and taking into solution.

T4 Temper is the heat treatment level. It is then held at 182 ° C for 3 hours to obtain T5 temper.

After obtaining T4 temper, it is kept at 177 ° C for 8 hours to obtain T66 temper. Tempers after T5 are known as artificial aging.

It is a process for increasing the hardness and strength of the material.

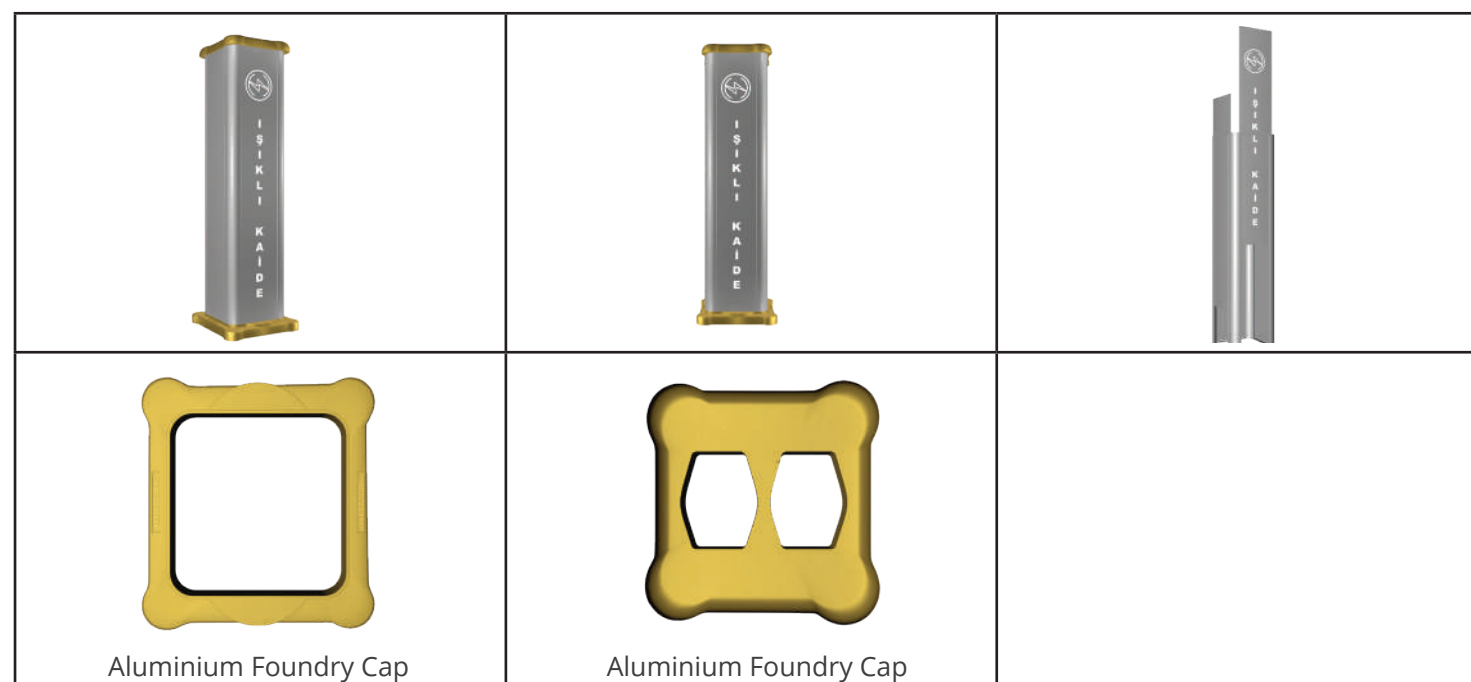

TEK TARAFLI AYDINLATMA GRUBU



ANATOLIA METRO 22-23

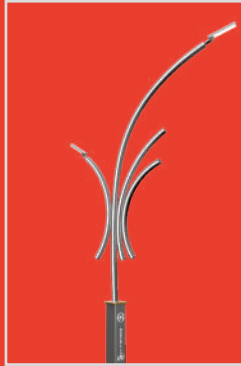

ANATOLIA ALPHA 24-25

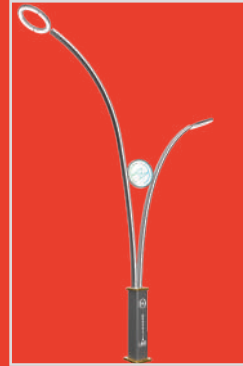

ANATOLIA FORCE 26-27

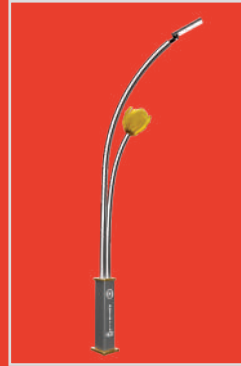

ANATOLIA METRO I 28-29



ANATOLIA SUPRAME 30-31



ANATOLIA TRIGON 32-33

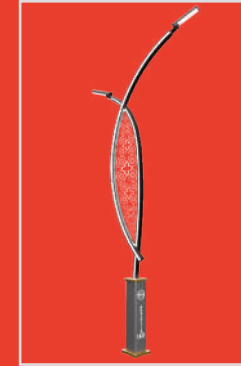

ANATOLIA ZEBRA 34-35



ANATOLIA BROW 36-37

TEK TARAFLI AYDINLATMA GRUBU

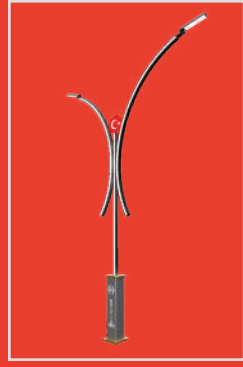

ANATOLIA TOROS 38-39

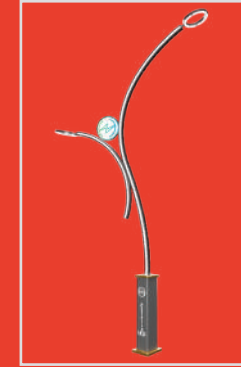

ANATOLIA TWIST 40-41



ANATOLIA BROW 42-43



ANATOLIA ESES 44-45

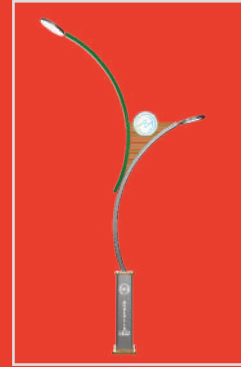

ANATOLIA RETURN 46-47



ANATOLIA SWAN 48-49



ANATOLIA GATHER 50-51



ANATOLIA STILL 52-53

TEK TARAFLI AYDINLATMA GRUBU

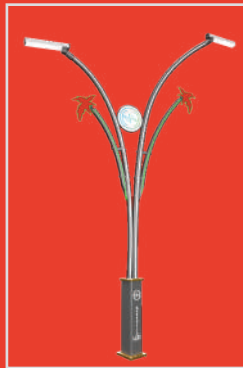

ANATOLIA PALM 54-55

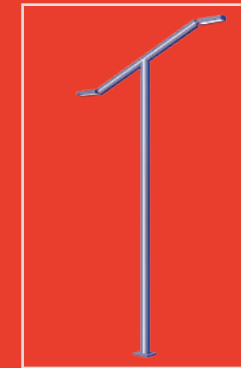

ANATOLIA T MODEL 56-57

REFUJ AYDINLATMA GRUBU

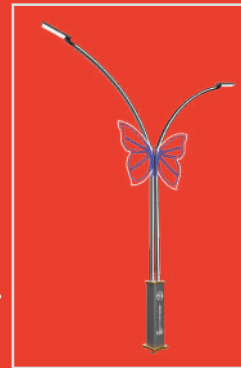

ANATOLIA BUTTERFLY 60-61

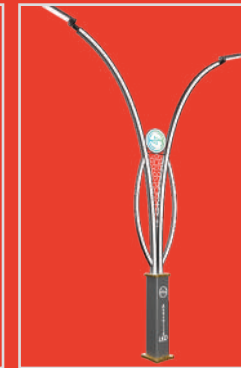

ANATOLIA BETA 62-63



ANATOLIA COURSE 64-65

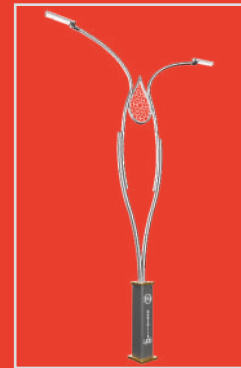

ANATOLIA DAMLA 66-67



ANATOLIA FISH 68-69

REFUJ AYDINLATMA GRUBU

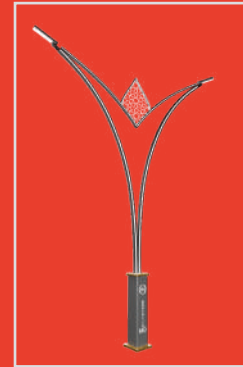

ANATOLIA PEAK 70-71



ANATOLIA ERCİYES 72-73



ANATOLIA APART 74-75

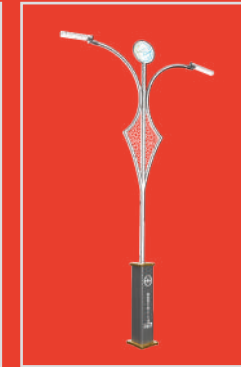

ANATOLIA ARROW 76-77

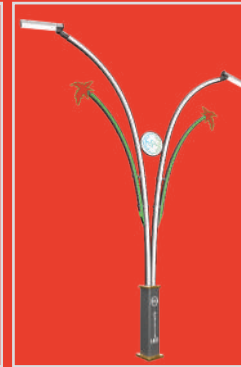

ANATOLIA PALM 78-79



ANATOLIA FREE 80-81

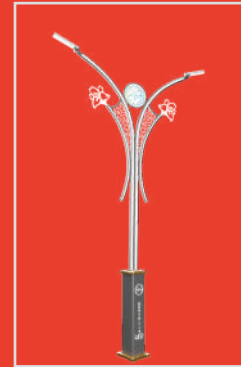

ANATOLIA JUMP 82-83

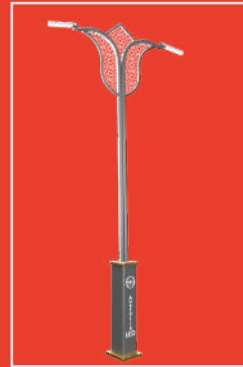

ANATOLIA LALE 84-85

REFUJ AYDINLATMA GRUBU

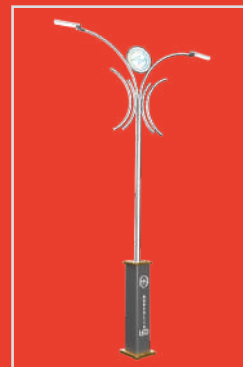

ANATOLIA POLY 86-87

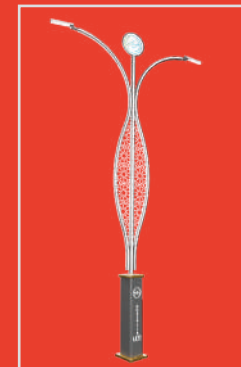

ANATOLIA ROMMY 88-89

ŞEHİR TAG AYDINLATMA GRUBU

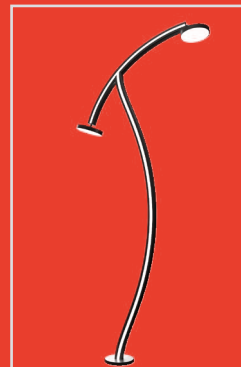

ANATOLIA CURVE 92-93

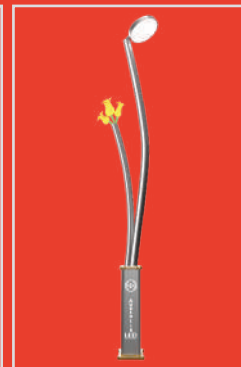

ANATOLIA FLOWER 94-95

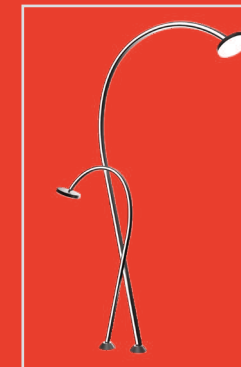

ANATOLIA LOVE 96-97

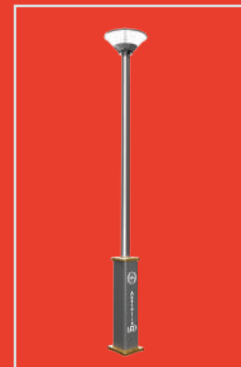

ANATOLIA UFO 98-99

KARE PROFİL AYDINLATMA GRUBU

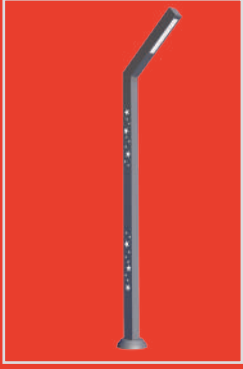

ANATOLIA ROOFING 102-103

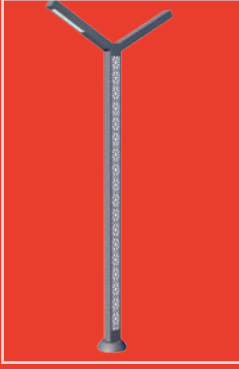

ANATOLIA VALE 104-105

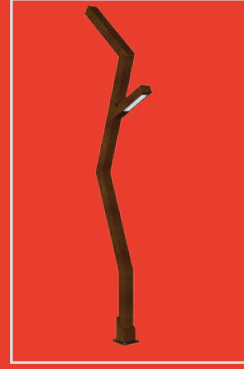

ANATOLIA TWING 106-107

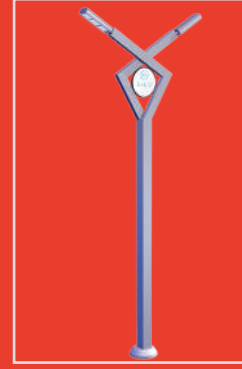

ANATOLIA EVEREST 108-109

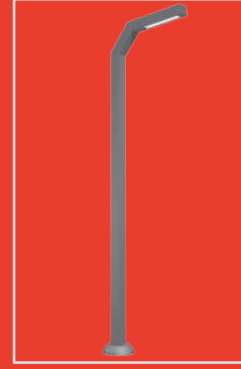

ANATOLIA HEXAGON 110-111



ANATOLIA GAP 112-113

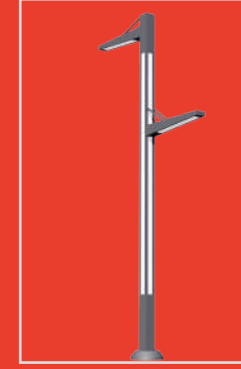

ANATOLIA POWERFUL 114-115

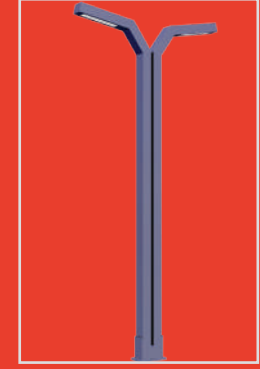

ANATOLIA ANOTHER 116-117

GÜNEŞ PANELLİ AYDINLATMA GRUBU

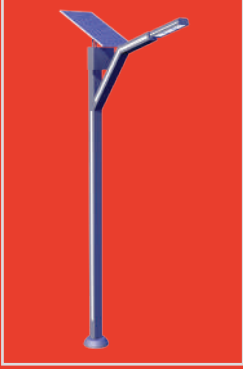

ANATOLIA SUN 120-121

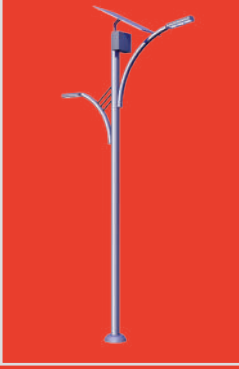

ANATOLIA SUNSHINE 122-123

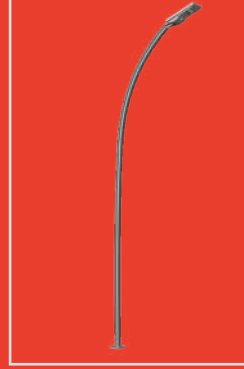

LED ARMATÜR 124-125

DEKORATİF AYDINLATMA GRUBU

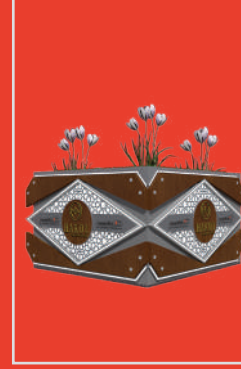

ANATOLIA SİDE 128-129

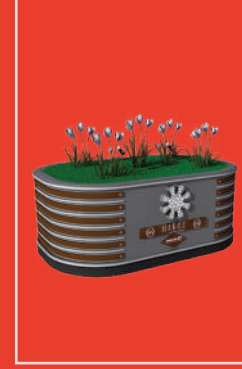

ANATOLIA ELİPS 130-131



ANATOLIA TUB 132-133



REKLAM PANO 134-135

MEYDAN AYDINLATMA GRUBU

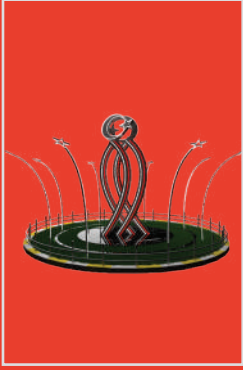

ARMOR 138-139

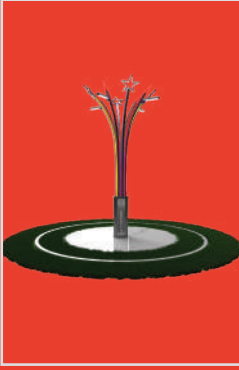

BUKET 140-141

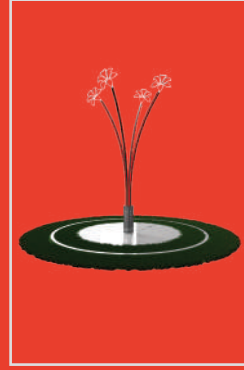

ÇİÇEK 142-143

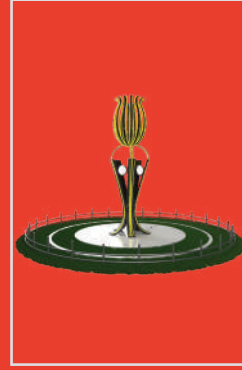

FLOWER 144-145

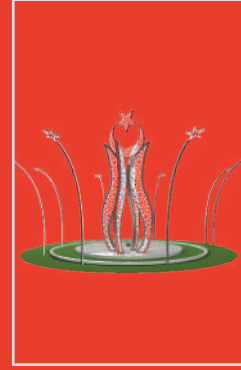

LALE 146-147

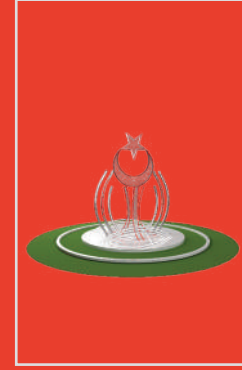

POWER OF STAR 148-149



TUĞRA 150-151

DURAK VE KORKULUK AYDINLATMA

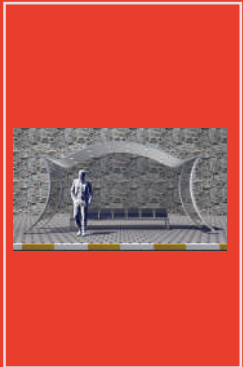

ANATOLIA 154-155

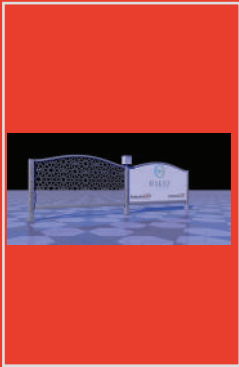

ANATOLIA SHAPE 156-157

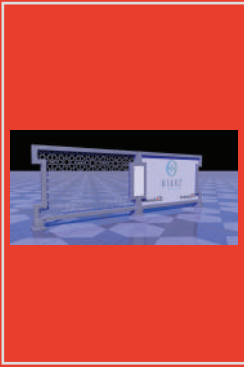

ANATOLIA SHARP 158-159

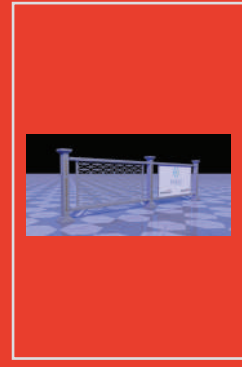

ANATOLIA MASTER 160-161

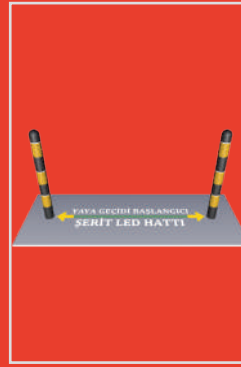

YAYA İKAZ SİSTEMİ 162-163

TAG AYDINLATMA GRUBU



ANATOLIA COOL 166-167



ANATOLIA YILDIZ 168-169

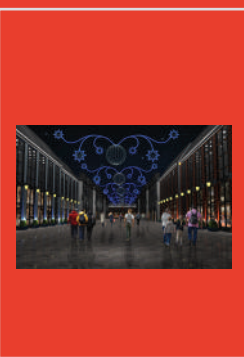

ANATOLIA SATURN 170-171

ŞEHİR TAG AYDINLATMA GRUBU

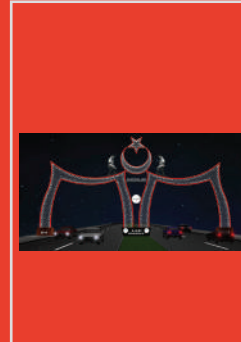

ŞEHİR TAG I 174-175

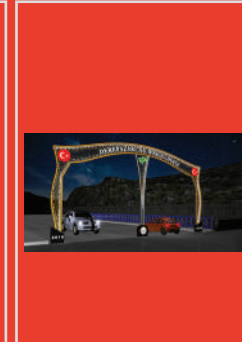

ŞEHİR TAG II 176-177

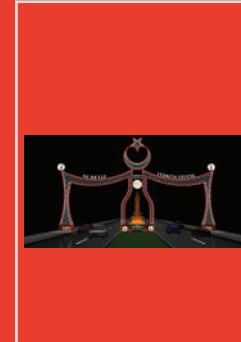

ŞEHİR TAG III 178-179

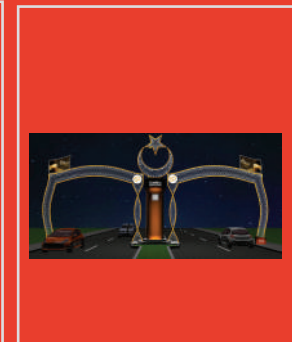

ŞEHİR TAG IV 180-181

Tek  
Taraflı  
Aydınlatma  
Grubu

One  
Sided  
Lighting  
Group

Anatolia LED®







## ANATOLIA METRO

Profil Detayı Profile Detail	Alüminyum Armatür Aluminum Armature	Armatür Kapak Armature Cover	Gövde Body	Kaide Tipi Base Type
			Alüminyum & Çelik Aluminium & Steel	Alüminyum & Çelik Aluminium & Steel

Şerit Led Detayı  
Led Strip Detail

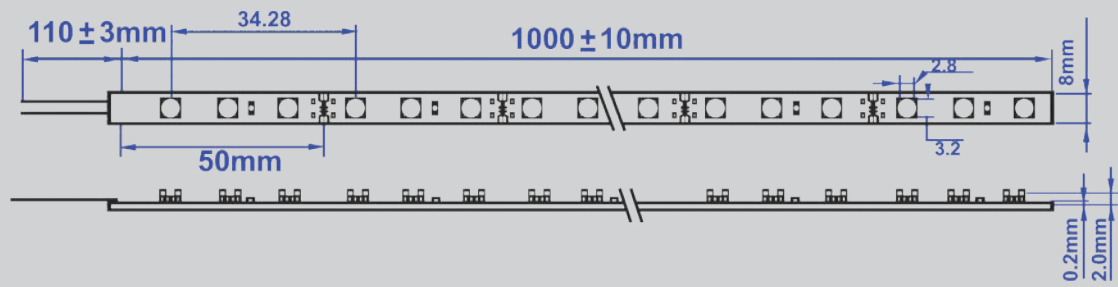

Ürün Belgeleri Product Documents			
Ürün Sertifikaları Product Certificates	TS EN 605 98-1-2 TS EN 605 98-1 TS 8700 EN 605 98-2-3	ISO 9001:2008 ISO 14001:2004 ISO 18002	OHSAS 18001:2007

**AnatoliaLED®**  
LED LIGHTING TECHNOLOGY



GRUP  
HAKÖZ®  
MÜHÜRÜZÜMÜSÜ & ENERJİSİZİMÜSÜ



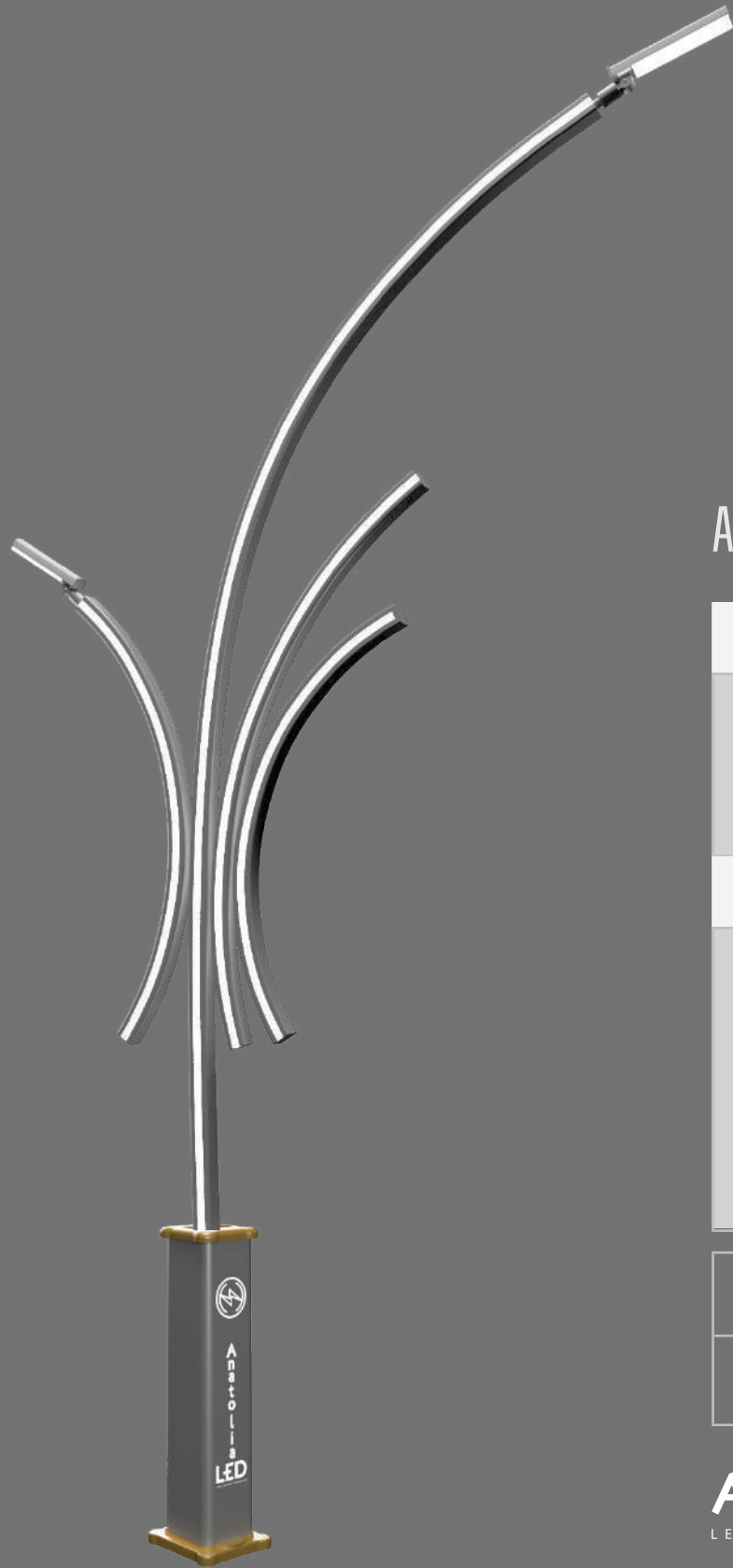

## ANATOLIA ALPHA

Profil Detayı Profile Detail	Alüminyum Armatür Aluminum Armature	Armatür Kapak Armature Cover	Gövde Body	Kaide Tipi Base Type
			Alüminyum & Çelik Aluminium & Steel	Alüminyum & Çelik Aluminium & Steel

Şerit Led Detay  
Led Strip Detail

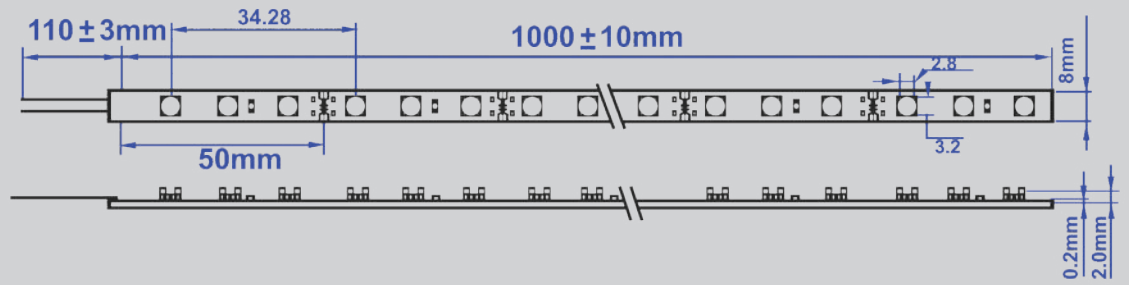

Ürün Belgeleri Product Documents			
Ürün Sertifikaları Product Certificates	TS EN 605 98-1-2 TS EN 605 98-1 TS 8700 EN 605 98-2-3	ISO 9001:2008 ISO 14001:2004 ISO 18002	OHSAS 18001:2007

**AnatoliaLED®**  
LED LIGHTING TECHNOLOGY



GRUP  
HAKÖZ®  
MÜHÜRÜMÜZÜ KULLANMAYI BİZE İZİN VERMEYİZ

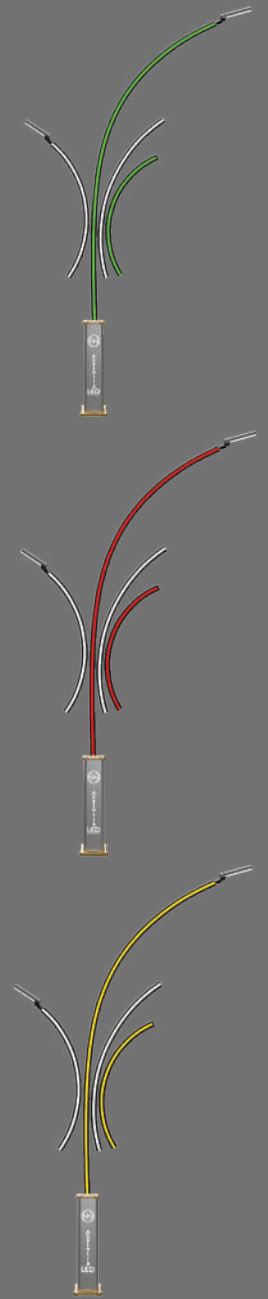

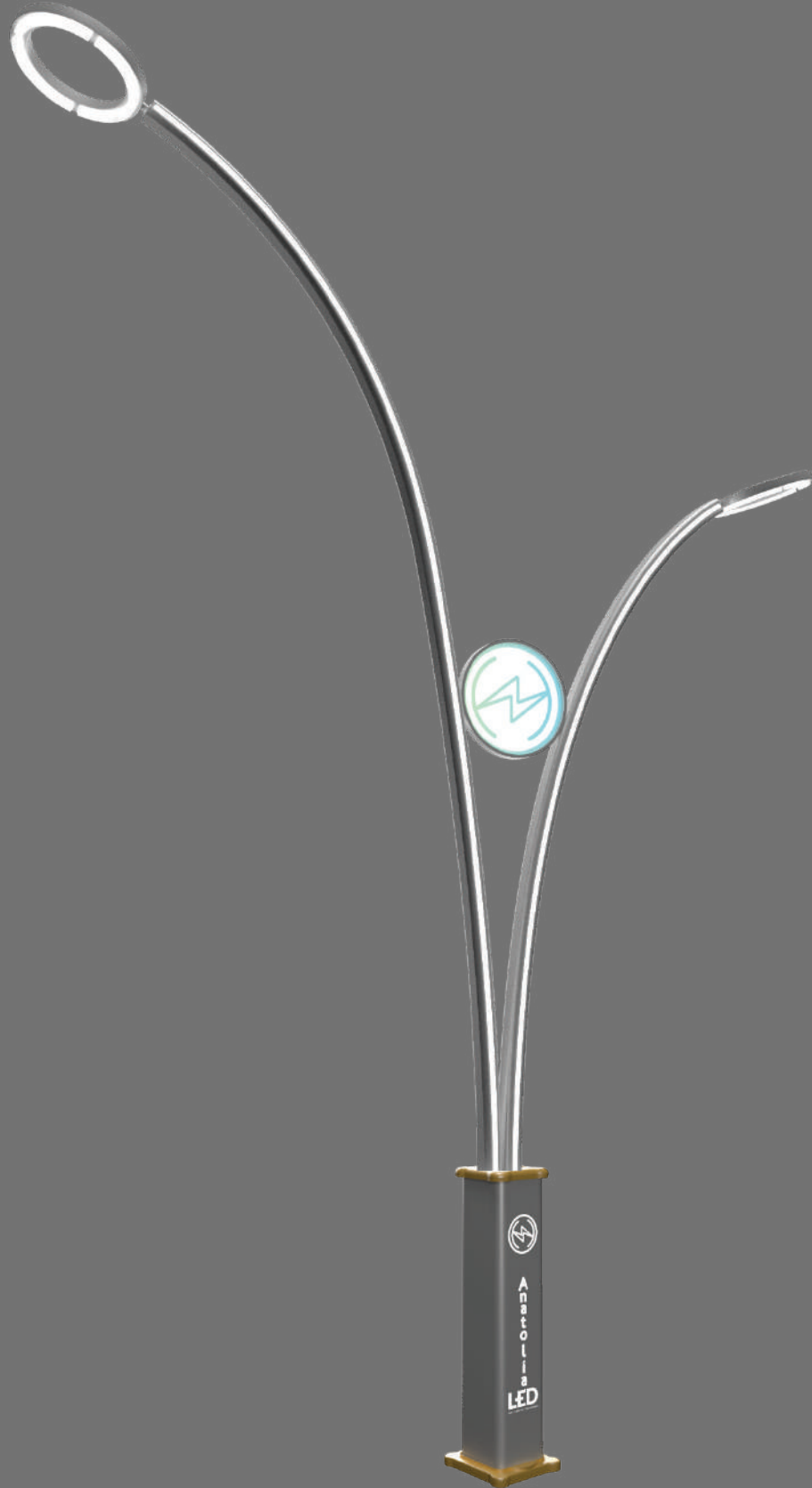

## ANATOLIA FORCE

Profil Detayı Profile Detail	Armatür Armature	Gövde Body	Kaide Tipi Base Type
		Alüminyum & Çelik Aluminium & Steel	Alüminyum & Çelik Aluminium & Steel

### Şerit Led Detay Led Strip Detail

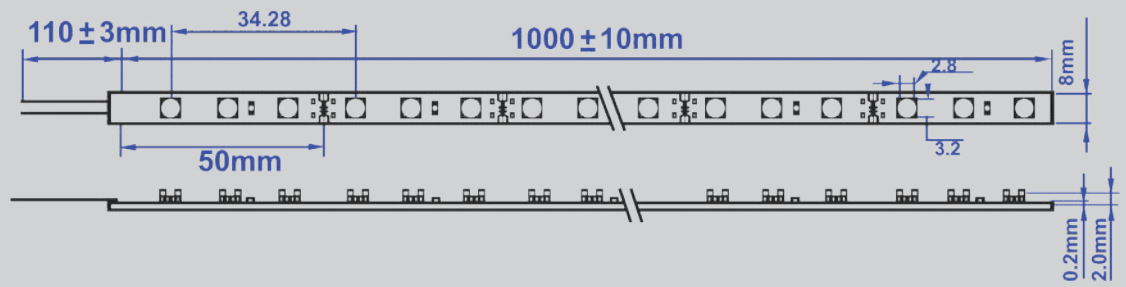

Ürün Belgeleri Product Documents			
Ürün Sertifikaları Product Certificates	TS EN 605 98-1-2 TS EN 605 98-1 TS 8700 EN 605 98-2-3	ISO 9001:2008 ISO 14001:2004 ISO 18002	OHSAS 18001:2007

**AnatoliaLED®**  
LED LIGHTING TECHNOLOGY



GRUP  
HAKÖZ®  
ENERJİ VE YATIRIM

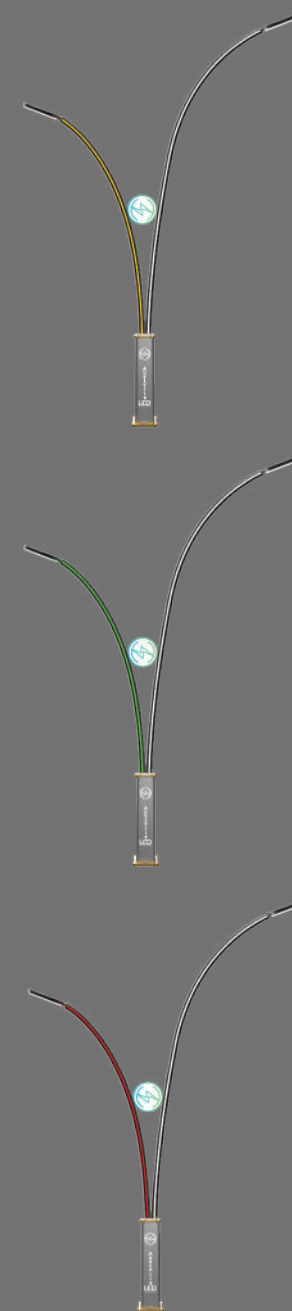

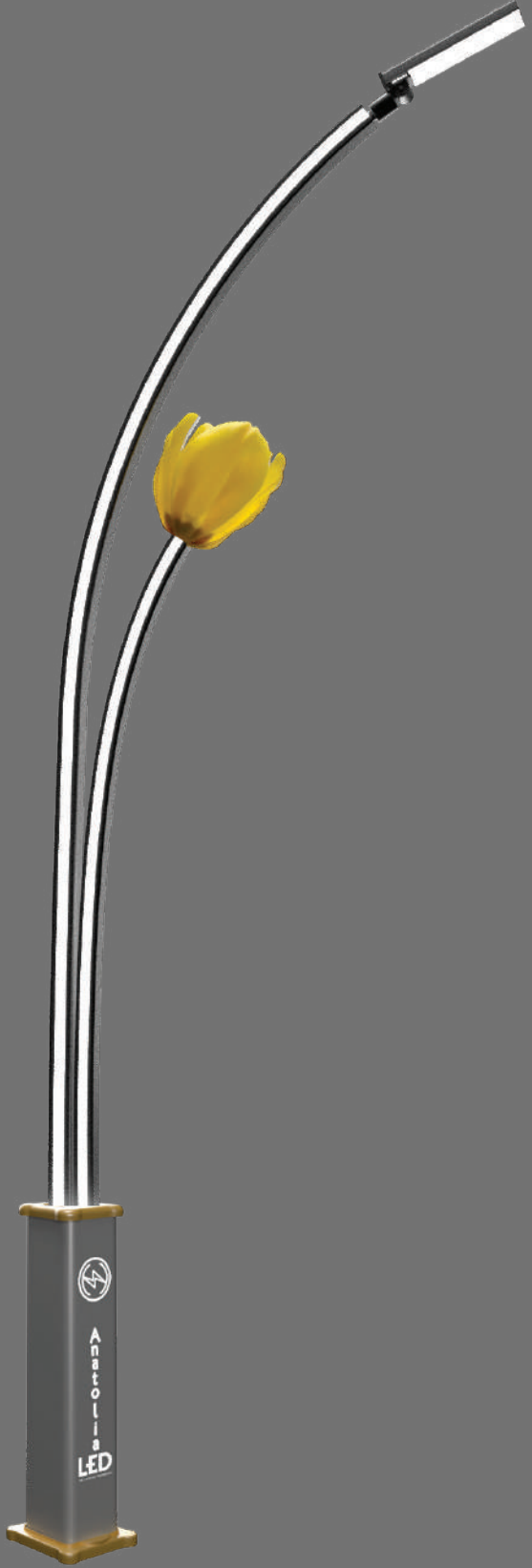

## ANATOLIA METRO I

Profil Detayı Profile Detail	Alüminyum Armatür Aluminum Armature	Armatür Kapak Armature Cover	Gövde Body	Kaide Tipi Base Type
			Alüminyum & Çelik Aluminium & Steel	Alüminyum & Çelik Aluminium & Steel

Şerit Led Detay  
Led Strip Detail

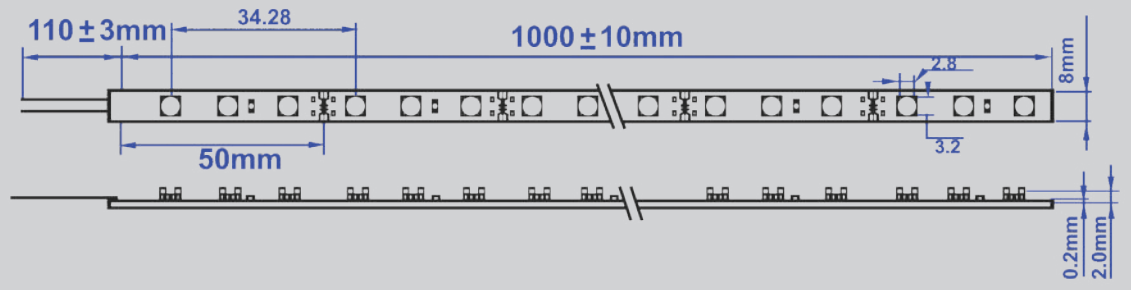

Ürün Belgeleri Product Documents			
Ürün Sertifikaları Product Certificates	TS EN 605 98-1-2 TS EN 605 98-1 TS 8700 EN 605 98-2-3	ISO 9001:2008 ISO 14001:2004 ISO 18002	OHSAS 18001:2007

**AnatoliaLED®**  
LED LIGHTING TECHNOLOGY



GRUP  
HAKÖZ®  
ENERJENİ KORUMA VE YAKARSAZLIK

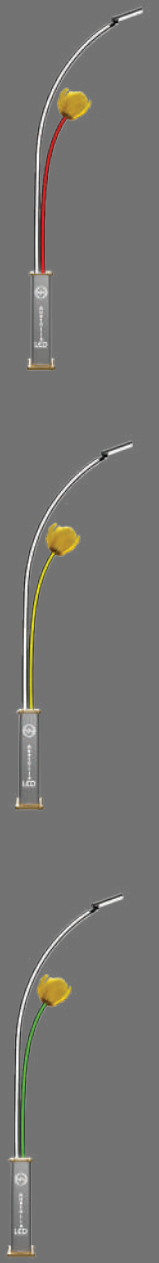

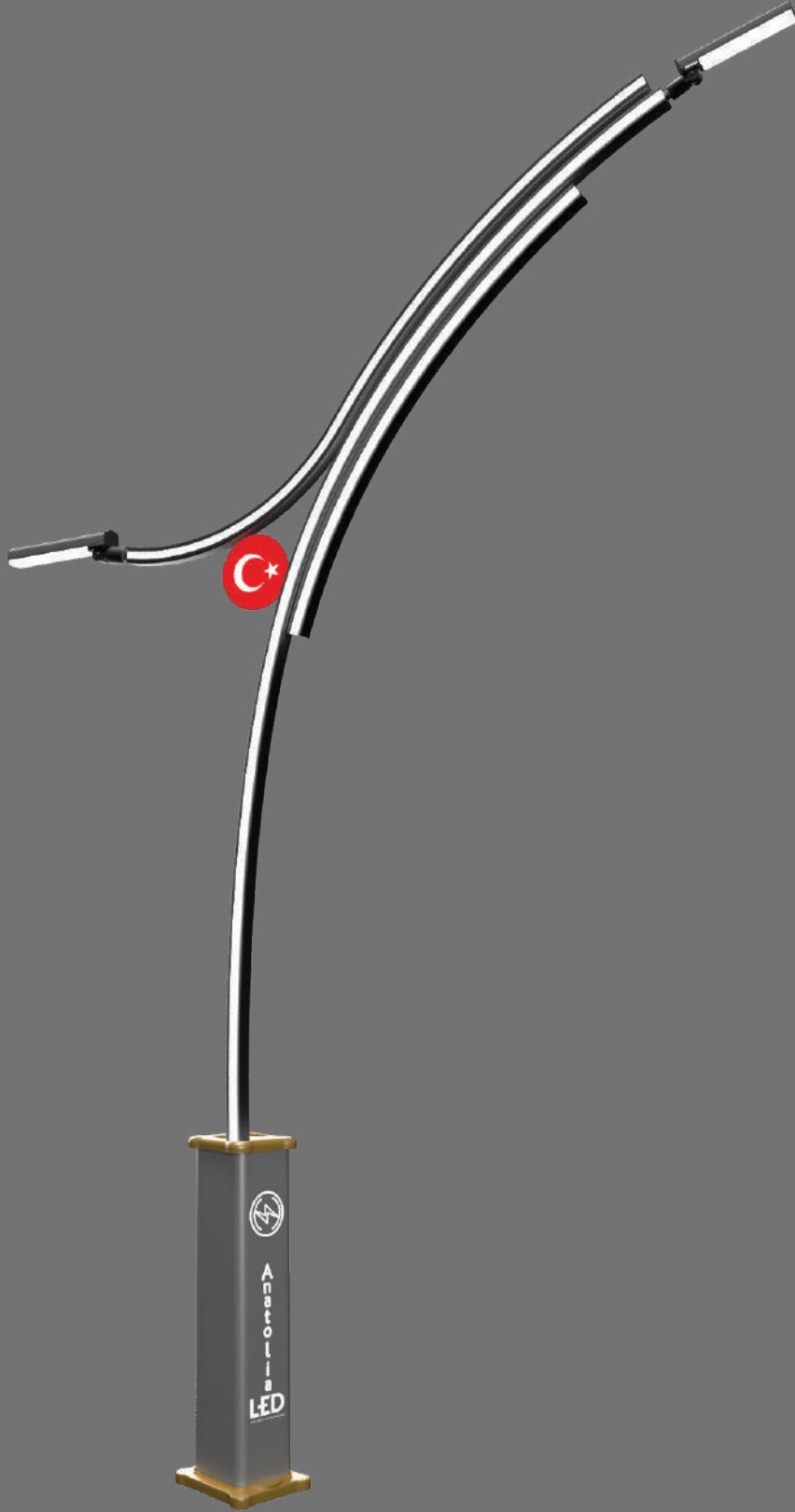

## ANATOLIA SUPRAME

Profil Detayı Profile Detail	Alüminyum Armatür Aluminum Armature	Armatür Kapak Armature Cover	Gövde Body	Kaide Tipi Base Type
			Alüminyum & Çelik Aluminium & Steel	Alüminyum & Çelik Aluminium & Steel

Şerit Led Detay  
Led Strip Detail

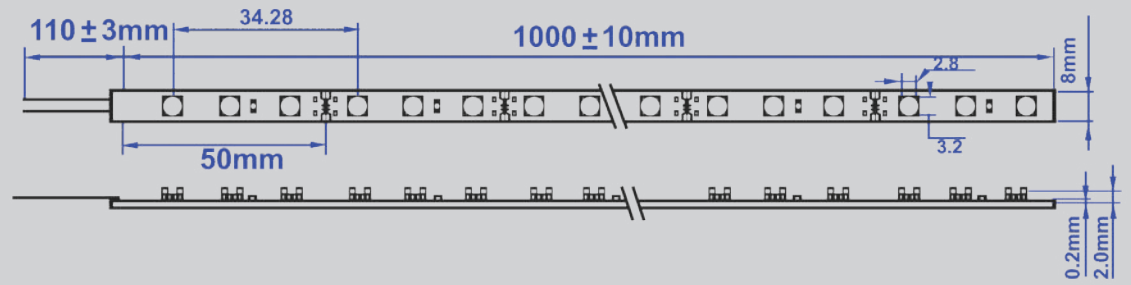

Ürün Belgeleri Product Documents			
Ürün Sertifikaları Product Certificates	TS EN 605 98-1-2 TS EN 605 98-1 TS 8700 EN 605 98-2-3	ISO 9001:2008 ISO 14001:2004 ISO 18002	OHSAS 18001:2007

**AnatoliaLED®**  
LED LIGHTING TECHNOLOGY



GRUP  
HAKÖZ®  
ENERJİ VE YATIRIM

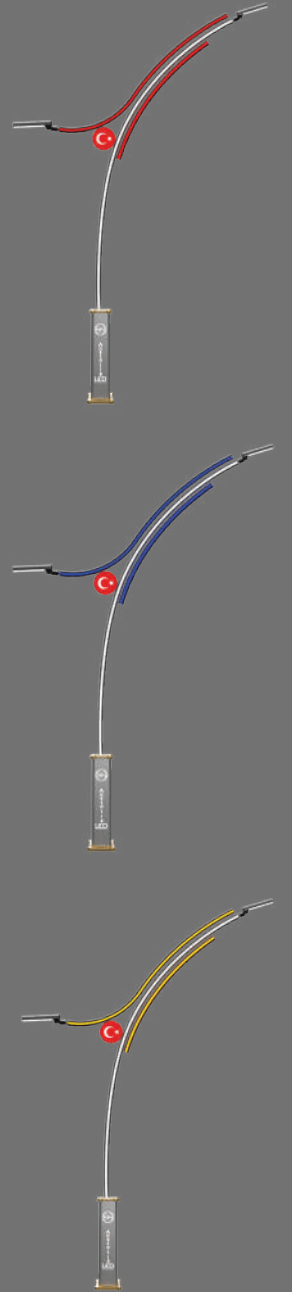

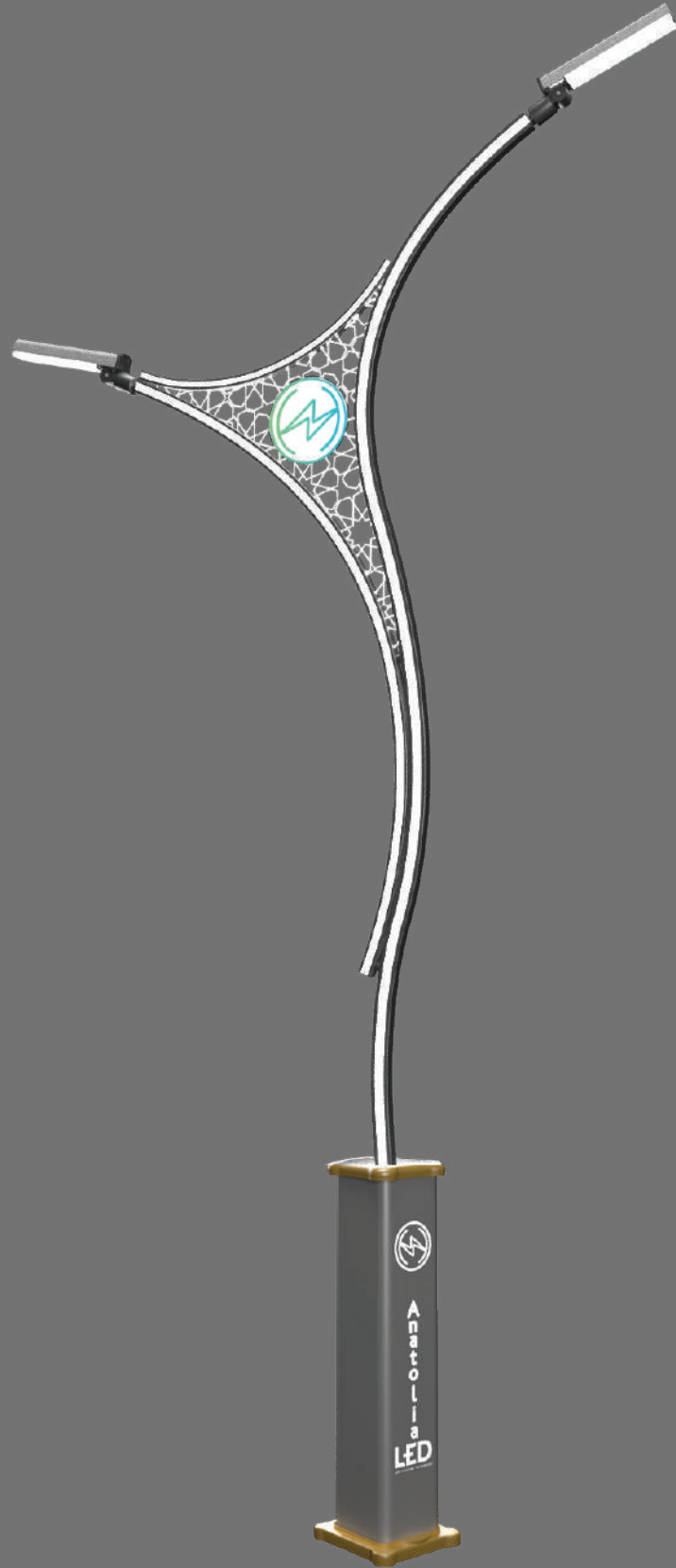

## ANATOLIA TRIGON

Profil Detayı Profile Detail	Alüminyum Armatür Aluminum Armature	Armatür Kapak Armature Cover	Gövde Body	Kaide Tipi Base Type
			Alüminyum & Çelik Aluminium & Steel	Alüminyum & Çelik Aluminium & Steel

Şerit Led Detay  
Led Strip Detail

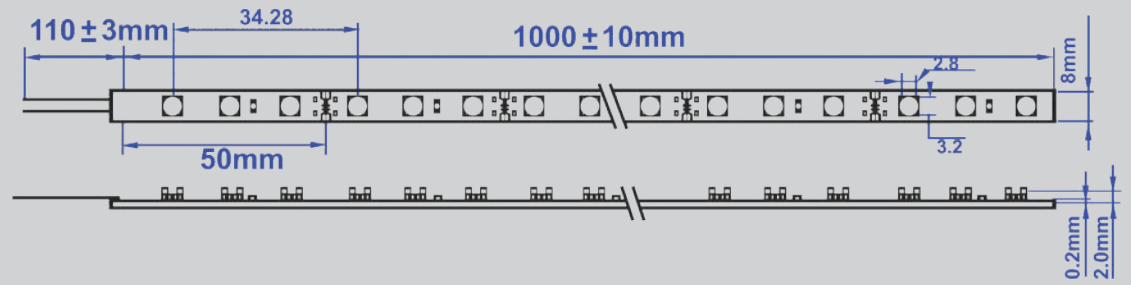

Ürün Belgeleri Product Documents			
Ürün Sertifikaları Product Certificates	TS EN 605 98-1-2 TS EN 605 98-1 TS 8700 EN 605 98-2-3	ISO 9001:2008 ISO 14001:2004 ISO 18002	OHSAS 18001:2007

**AnatoliaLED®**  
LED LIGHTING TECHNOLOGY



GRUP  
HAKÖZ®  
ENERJENİ KORUMA VE YAKARSAZLIK



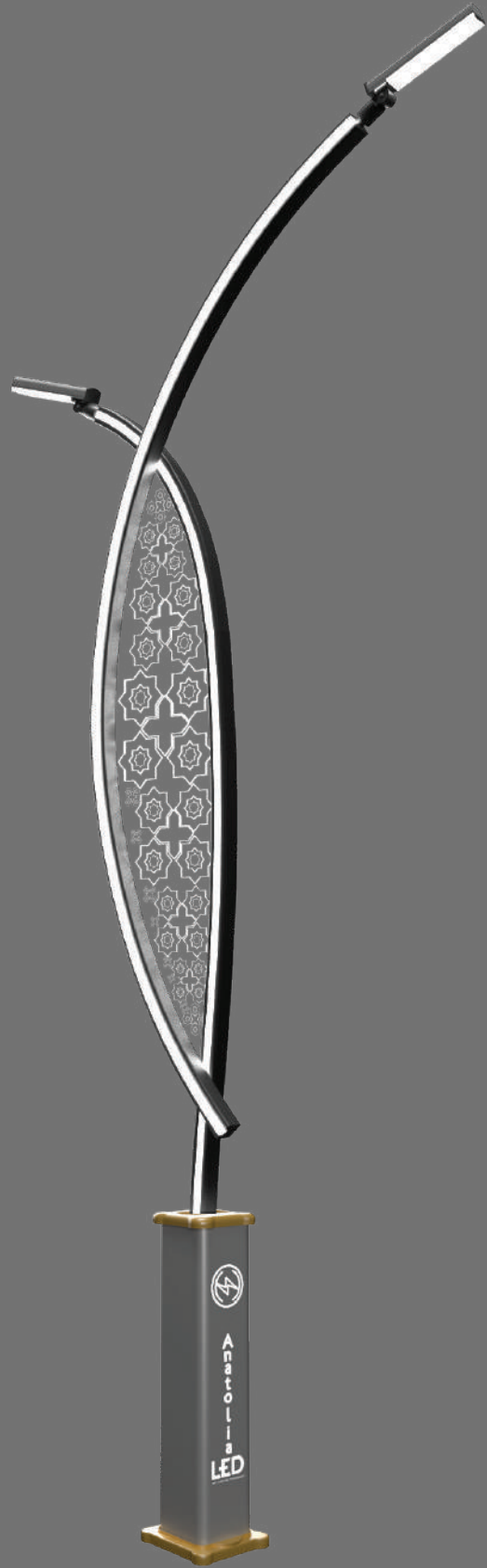

## ANATOLIA ZEBRA

Profil Detayı Profile Detail	Alüminyum Armatür Aluminum Armature	Armatür Kapak Armature Cover	Gövde Body	Kaide Tipi Base Type
			Alüminyum & Çelik Aluminium & Steel	Alüminyum & Çelik Aluminium & Steel

Şerit Led Detay  
Led Strip Detail

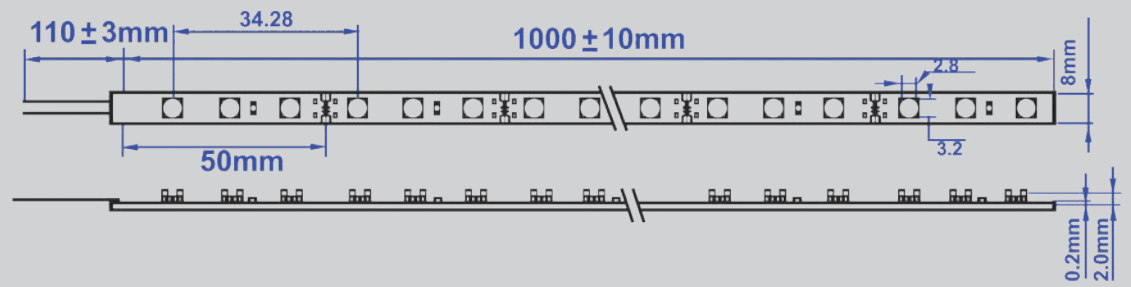

Ürün Belgeleri Product Documents			
Ürün Sertifikaları Product Certificates	TS EN 605 98-1-2 TS EN 605 98-1 TS 8700 EN 605 98-2-3	ISO 9001:2008 ISO 14001:2004 ISO 18002	OHSAS 18001:2007

**AnatoliaLED®**  
LED LIGHTING TECHNOLOGY



GRUP  
HAKÖZ®  
PROJEKTANT & MONTAŽNÍK

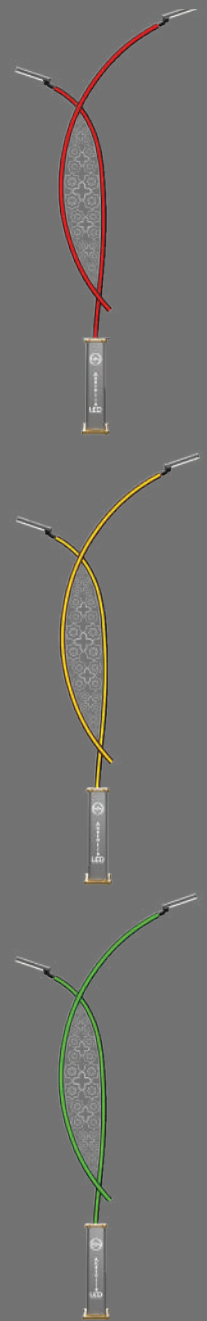

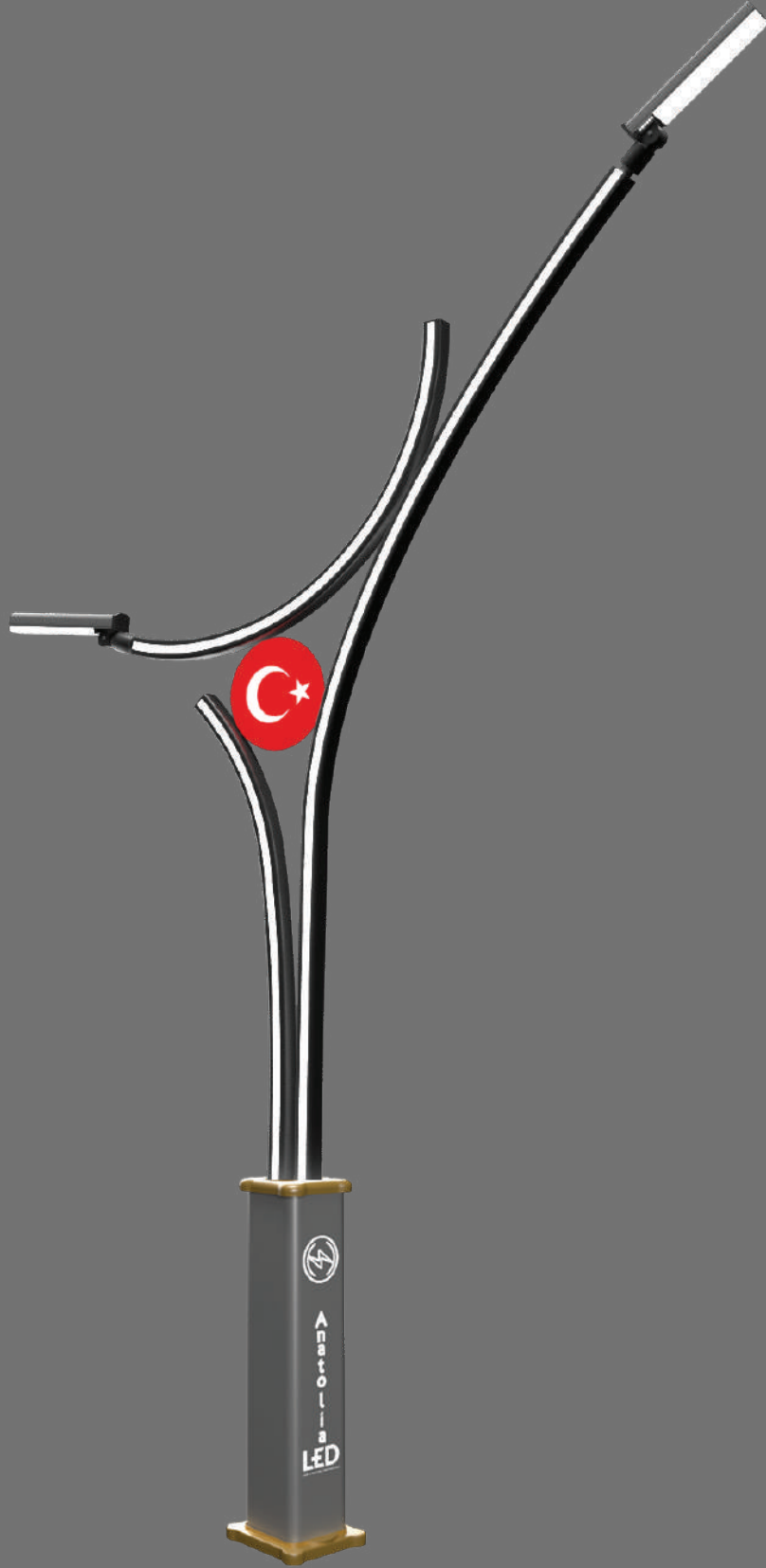

## ANATOLIA BROW

Profil Detayı Profile Detail	Alüminyum Armatür Aluminum Armature	Armatür Kapak Armature Cover	Gövde Body	Kaide Tipi Base Type
			Alüminyum & Çelik Aluminium & Steel	Alüminyum & Çelik Aluminium & Steel

### Şerit Led Detay Led Strip Detail

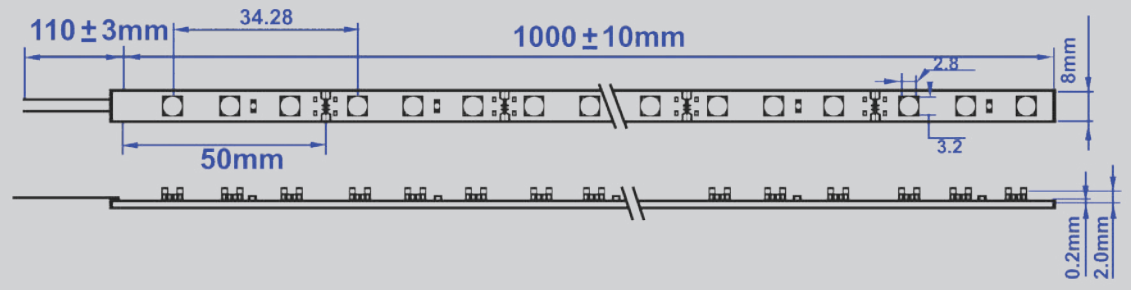

Ürün Belgeleri Product Documents			
Ürün Sertifikaları Product Certificates	TS EN 605 98-1-2 TS EN 605 98-1 TS 8700 EN 605 98-2-3	ISO 9001:2008 ISO 14001:2004 ISO 18002	OHSAS 18001:2007

**AnatoliaLED®**  
LED LIGHTING TECHNOLOGY



GRUP  
HAKÖZ®  
ENERJİ VE AYDINLATMA

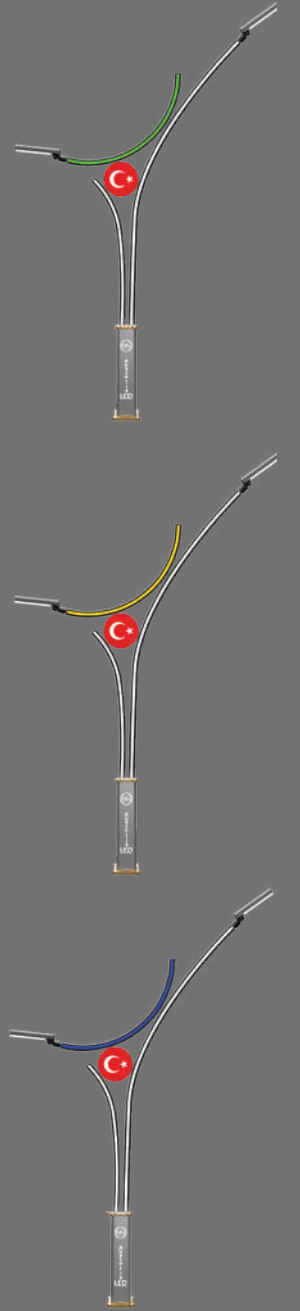

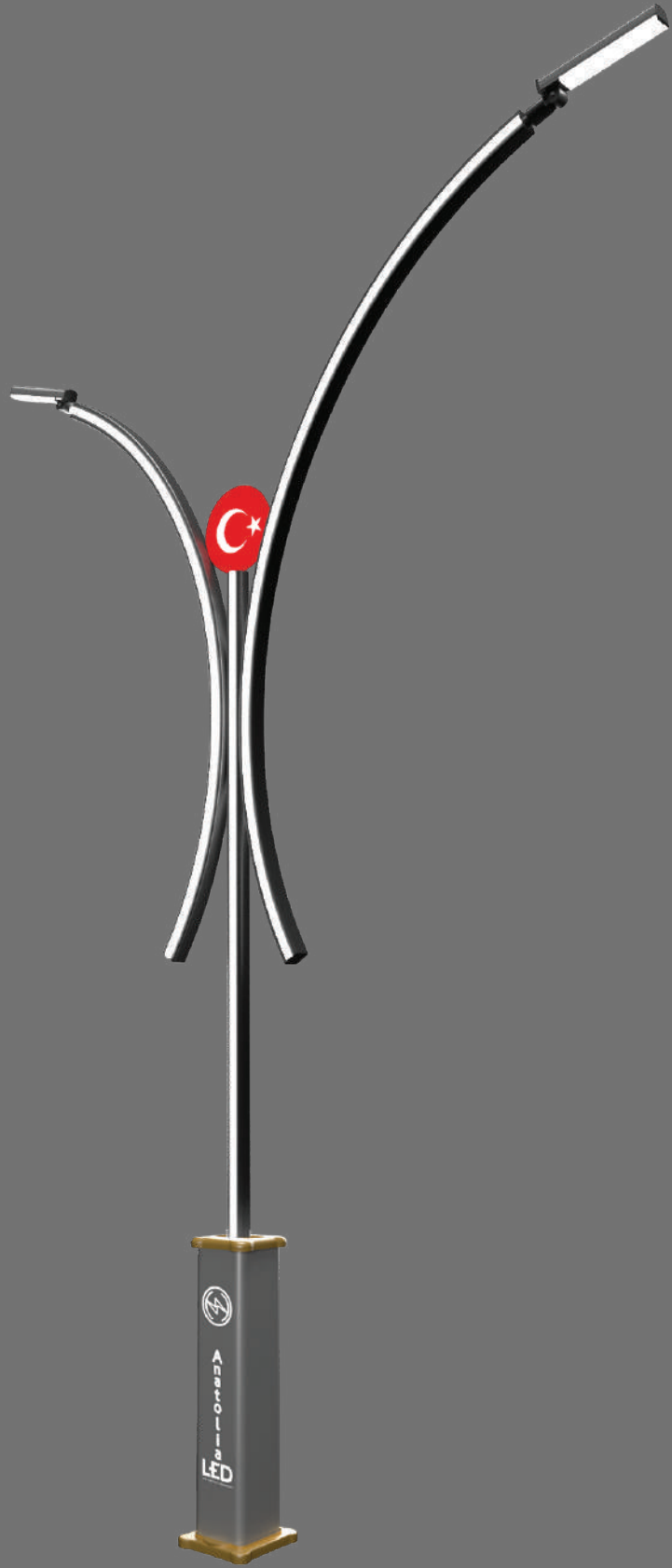

## ANATOLIA TOROS

Profil Detayı Profile Detail	Alüminyum Armatür Aluminum Armature	Armatür Kapak Armature Cover	Gövde Body	Kaide Tipi Base Type
			Alüminyum & Çelik Aluminium & Steel	Alüminyum & Çelik Aluminium & Steel

Şerit Led Detay  
Led Strip Detail

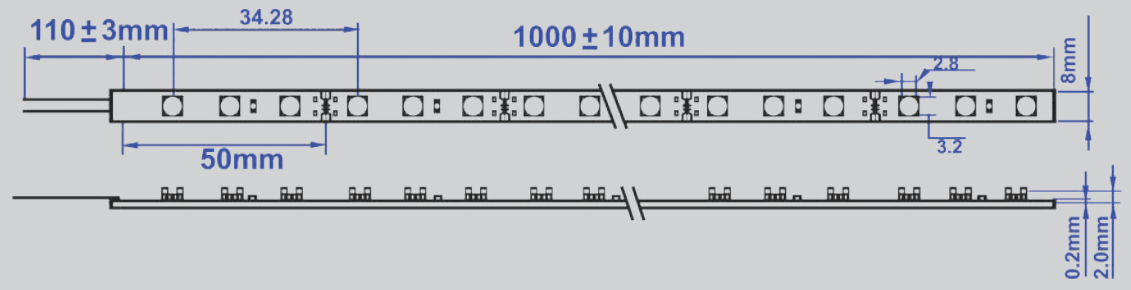

Ürün Belgeleri Product Documents			
Ürün Sertifikaları Product Certificates	TS EN 605 98-1-2 TS EN 605 98-1 TS 8700 EN 605 98-2-3	ISO 9001:2008 ISO 14001:2004 ISO 18002	OHSAS 18001:2007

**AnatoliaLED®**  
LED LIGHTING TECHNOLOGY



GRUP  
HAKÖZ®  
ENERJİ VE AYDINLATMA

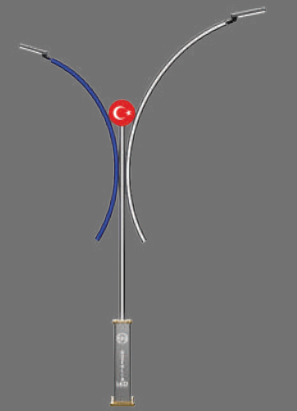
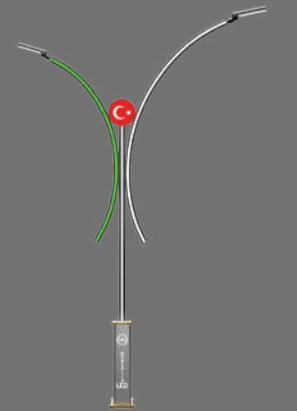
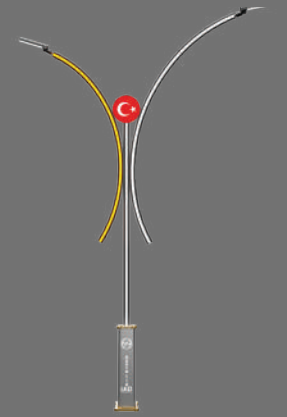

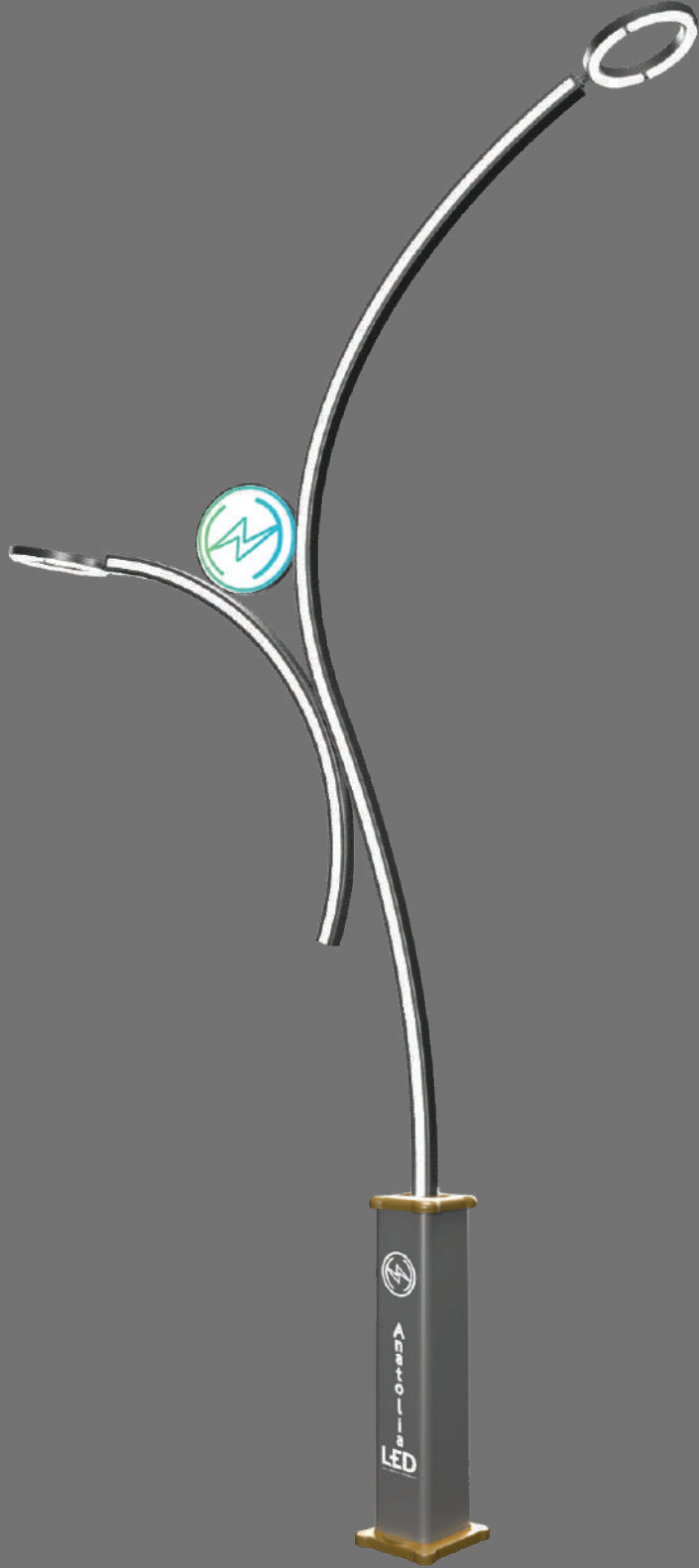

## ANATOLIA TWIST

Profil Detayı Profile Detail	Armatür Armature	Gövde Body	Kaide Tipi Base Type
		Alüminyum & Çelik Aluminium & Steel	Alüminyum & Çelik Aluminium & Steel
Şerit Led Detay Led Strip Detail			
Ürün Belgeleri Product Documents			
Ürün Sertifikaları Product Certificates	TS EN 605 98-1-2 TS EN 605 98-1 TS 8700 EN 605 98-2-3	ISO 9001:2008 ISO 14001:2004 ISO 18002	OHSAS 18001:2007

**AnatoliaLED®**  
LED LIGHTING TECHNOLOGY



GRUP  
HAKÖZ®  
ENERGIJA I VEŠTOSTI

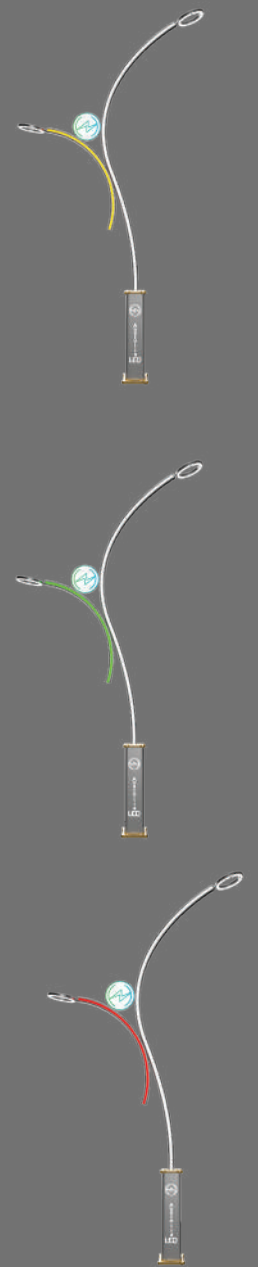



## ANATOLIA BROW

Profil Detayı Profile Detail	Alüminyum Armatür Aluminum Armature	Armatür Kapak Armature Cover	Gövde Body	Kaide Tipi Base Type
			Alüminyum & Çelik Aluminium & Steel	Alüminyum & Çelik Aluminium & Steel

Şerit Led Detay  
Led Strip Detail

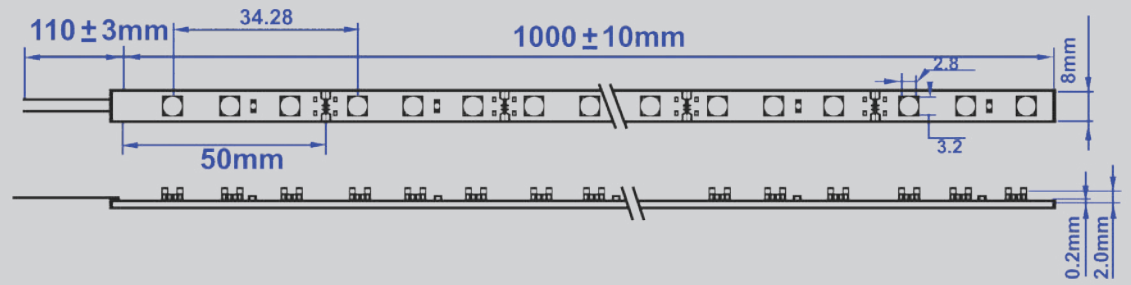

Ürün Belgeleri Product Documents			
Ürün Sertifikaları Product Certificates	TS EN 605 98-1-2 TS EN 605 98-1 TS 8700 EN 605 98-2-3	ISO 9001:2008 ISO 14001:2004 ISO 18002	OHSAS 18001:2007

**AnatoliaLED®**  
LED LIGHTING TECHNOLOGY



  
GRUP HAKOZ®  
ENERJİLER VE ENERJİLER

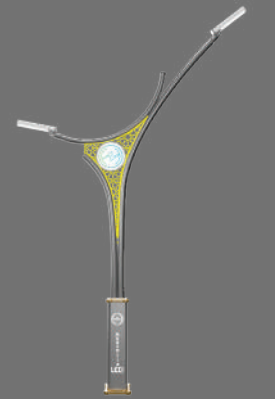



## ANATOLIA ESES

Profil Detayı Profile Detail	Alüminyum Armatür Aluminum Armature	Armatür Kapak Armature Cover	Gövde Body	Kaide Tipi Base Type
			Alüminyum & Çelik Aluminium & Steel	Alüminyum & Çelik Aluminium & Steel

Şerit Led Detay  
Led Strip Detail

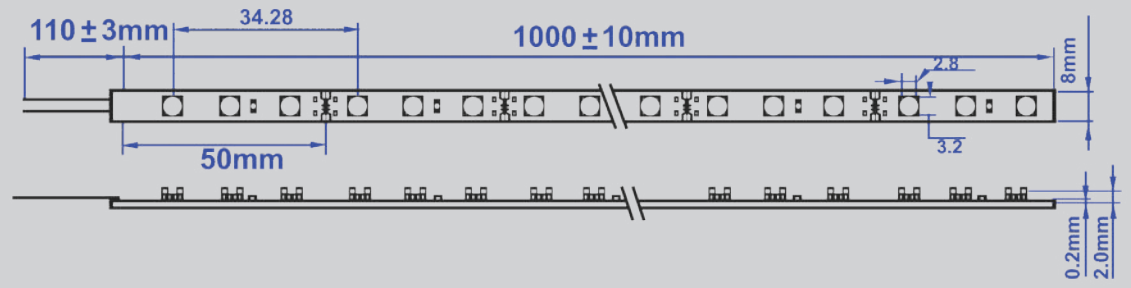

Ürün Belgeleri Product Documents			
Ürün Sertifikaları Product Certificates	TS EN 605 98-1-2 TS EN 605 98-1 TS 8700 EN 605 98-2-3	ISO 9001:2008 ISO 14001:2004 ISO 18002	OHSAS 18001:2007

**AnatoliaLED®**  
LED LIGHTING TECHNOLOGY



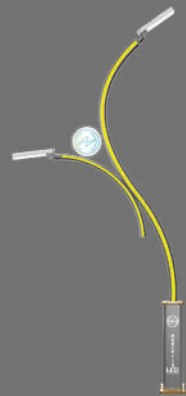
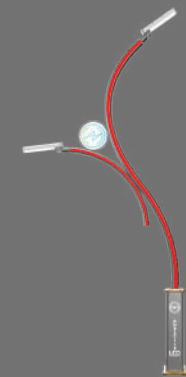
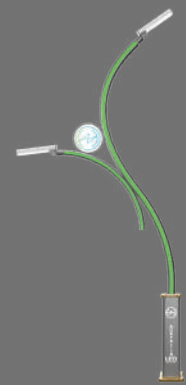

GRUP  
HAKÖZ®  
ENERJİ VE YATIRIM



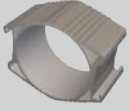

## ANATOLIA RETURN

Profil Detayı Profile Detail	Armatür Armature	Gövde Body	Kaide Tipi Base Type
		Alüminyum & Çelik Aluminium & Steel	Alüminyum & Çelik Aluminium & Steel

Şerit Led Detay  
Led Strip Detail

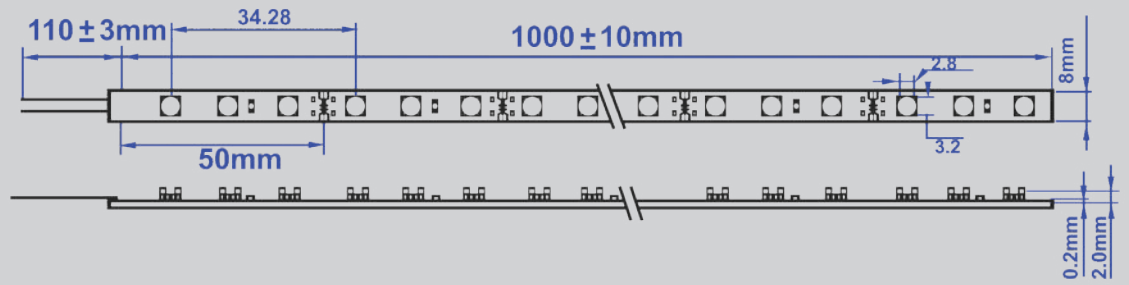

Ürün Belgeleri Product Documents			
Ürün Sertifikaları Product Certificates	TS EN 605 98-1-2 TS EN 605 98-1 TS 8700 EN 605 98-2-3	ISO 9001:2008 ISO 14001:2004 ISO 18002	OHSAS 18001:2007

**AnatoliaLED**<sup>®</sup>  
LED LIGHTING TECHNOLOGY



GRUP  
HAKÖZ®  
ENERJİNİ KORU







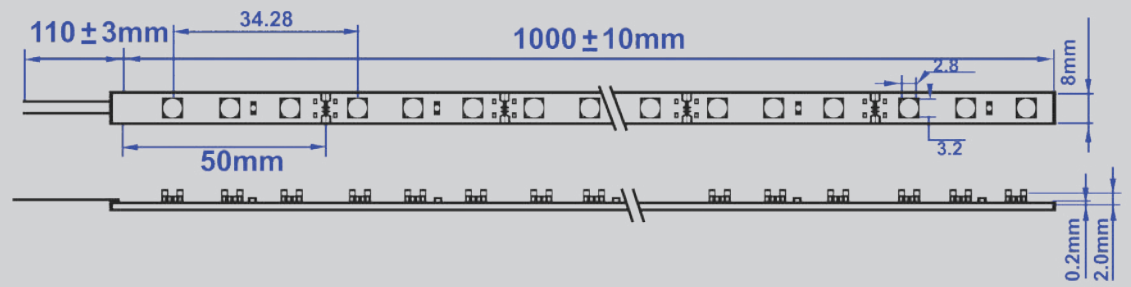

## ANATOLIA SWAN

Profil Detayı Profile Detail	Alüminyum Armatür Aluminum Armature	Armatür Kapak Armature Cover	Gövde Body	Kaide Tipi Base Type
			Alüminyum & Çelik Aluminium & Steel	Alüminyum & Çelik Aluminium & Steel

Şerit Led Detay  
Led Strip Detail



Ürün Belgeleri Product Documents			
Ürün Sertifikaları Product Certificates	TS EN 605 98-1-2 TS EN 605 98-1 TS 8700 EN 605 98-2-3	ISO 9001:2008 ISO 14001:2004 ISO 18002	OHSAS 18001:2007

**AnatoliaLED®**  
LED LIGHTING TECHNOLOGY



GRUP  
HAKÖZ®  
PROJEKTANT & MONTAŻYSTA

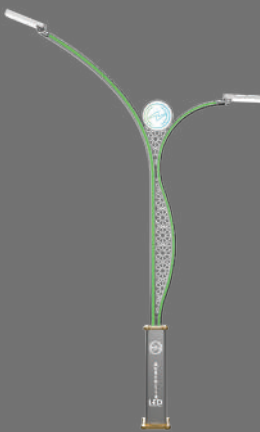
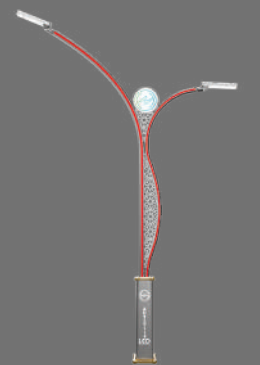
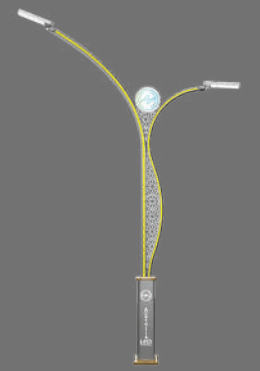

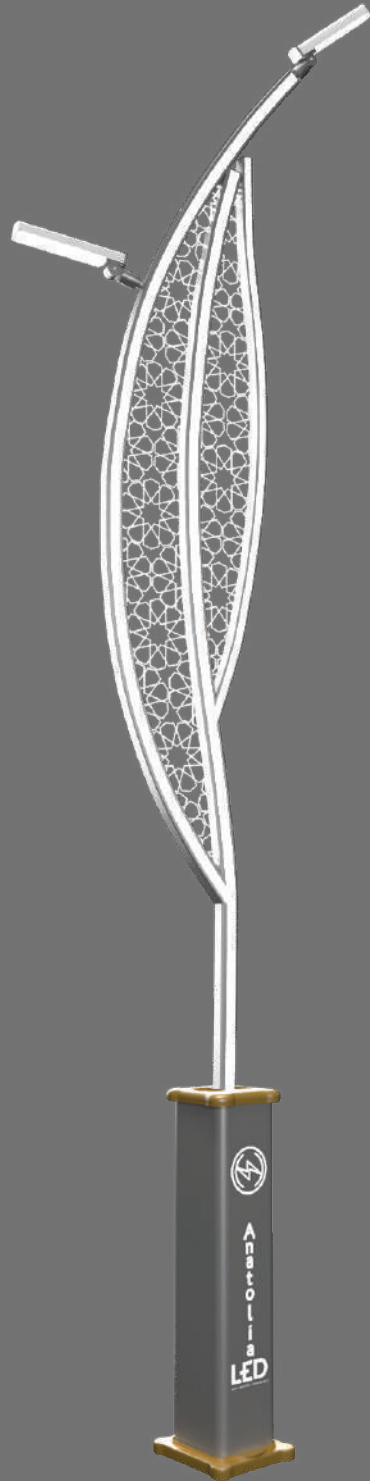

## ANATOLIA GATHER

Profil Detayı Profile Detail	Alüminyum Armatür Aluminum Armature	Armatür Kapak Armature Cover	Gövde Body	Kaide Tipi Base Type
			Alüminyum & Çelik Aluminium & Steel	Alüminyum & Çelik Aluminium & Steel

Şerit Led Detay  
Led Strip Detail

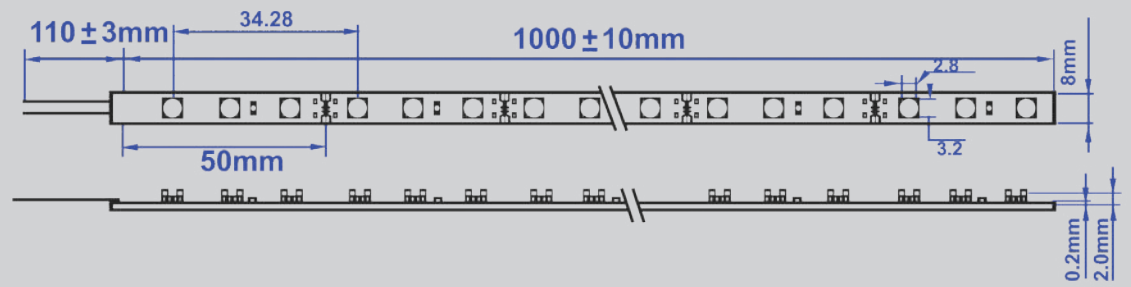

Ürün Belgeleri Product Documents			
Ürün Sertifikaları Product Certificates	TS EN 605 98-1-2 TS EN 605 98-1 TS 8700 EN 605 98-2-3	ISO 9001:2008 ISO 14001:2004 ISO 18002	OHSAS 18001:2007

**AnatoliaLED®**  
LED LIGHTING TECHNOLOGY



GRUP  
HAKÖZ®  
ENERJİ YATIRIM VE İNŞAAT A.Ş.

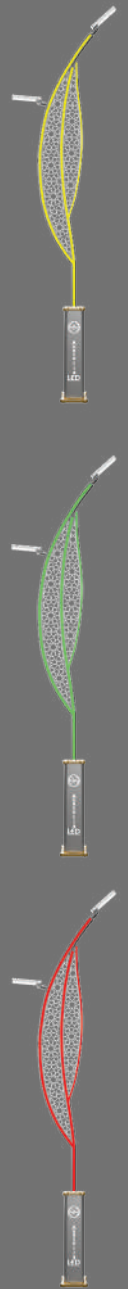



## ANATOLIA STILL

Profil Detayı Profile Detail	Alüminyum Armatür Aluminum Armature	Armatür Kapak Armature Cover	Gövde Body	Kaide Tipi Base Type
			Alüminyum & Çelik Aluminium & Steel	Alüminyum & Çelik Aluminium & Steel

Şerit Led Detayı  
Led Strip Detail

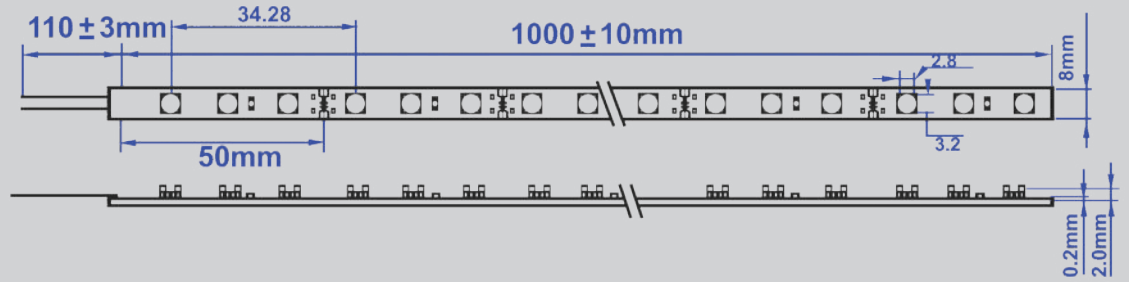

Ürün Belgeleri Product Documents			
Ürün Sertifikaları Product Certificates	TS EN 605 98-1-2 TS EN 605 98-1 TS 8700 EN 605 98-2-3	ISO 9001:2008 ISO 14001:2004 ISO 10002	OHSAS 18001:2007

**AnatoliaLED**  
LED LIGHTING TECHNOLOGY



  
HAKÖZ®  
ENERJİYİ KORUYAN







## ANATOLIA PALM

Profil Detayı Profile Detail	Alüminyum Armatür Aluminum Armature	Armatür Kapak Armature Cover	Gövde Body	Kaide Tipi Base Type
			Alüminyum & Çelik Aluminium & Steel	Alüminyum & Çelik Aluminium & Steel

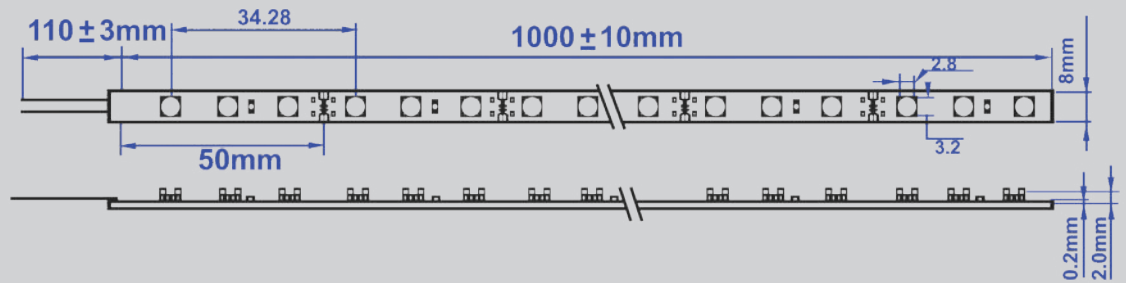
### Şerit Led Detayı Led Strip Detail



Ürün Belgeleri Product Documents			
Ürün Sertifikaları Product Certificates	TS EN 605 98-1-2 TS EN 605 98-1 TS 8700 EN 605 98-2-3	ISO 9001:2008 ISO 14001:2004 ISO 10002	OHSAS 18001:2007

**AnatoliaLED**  
LED LIGHTING TECHNOLOGY



  
HAKÖZ®  
ILLUMINATION & ARCHITECTURE



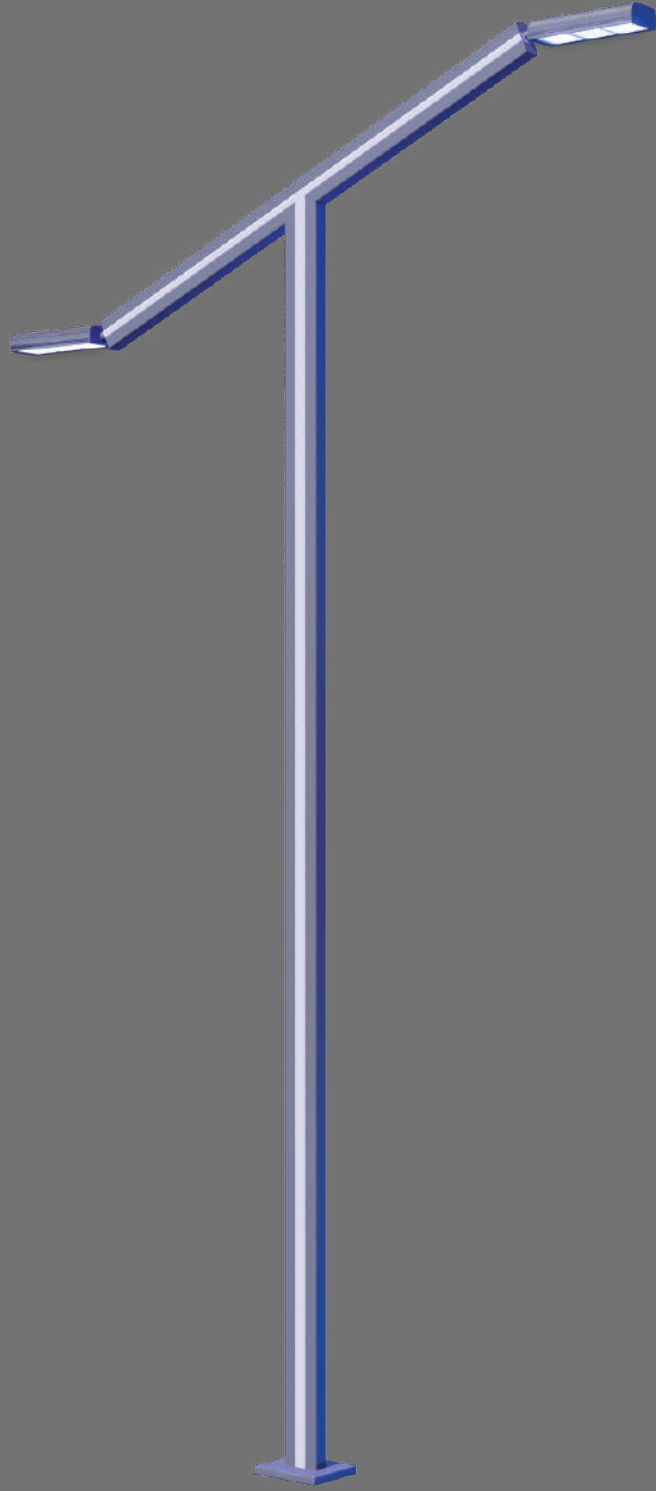

## ANATOLIA T MODEL

Profil Detayı Profile Detail	Alüminyum Armatür Aluminum Armature	Armatür Kapak Armature Cover	Gövde Body	Kaide Tipi Base Type
			Alüminyum & Çelik Aluminium & Steel	Alüminyum & Çelik Aluminium & Steel

Şerit Led Detay  
Led Strip Detail

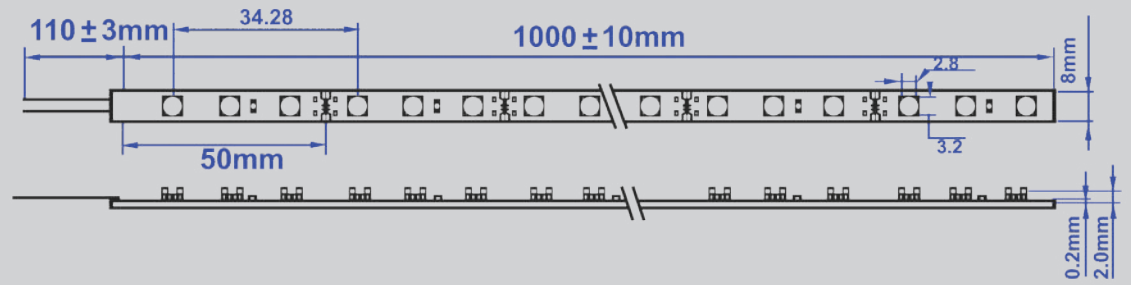

Ürün Belgeleri Product Documents			
Ürün Sertifikaları Product Certificates	TS EN 605 98-1-2 TS EN 605 98-1 TS 8700 EN 605 98-2-3	ISO 9001:2008 ISO 14001:2004 ISO 18002	OHSAS 18001:2007

**AnatoliaLED®**  
LED LIGHTING TECHNOLOGY

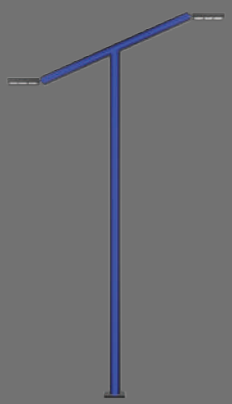
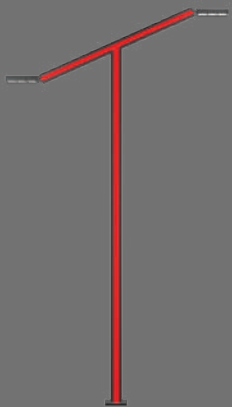
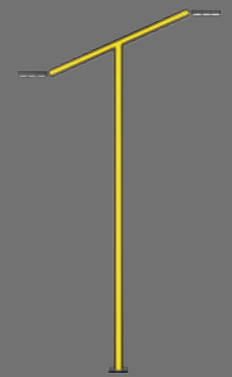

Refüj  
Aydınlatma  
Grubu

Median  
Lighting  
Group

Anatolia LED®





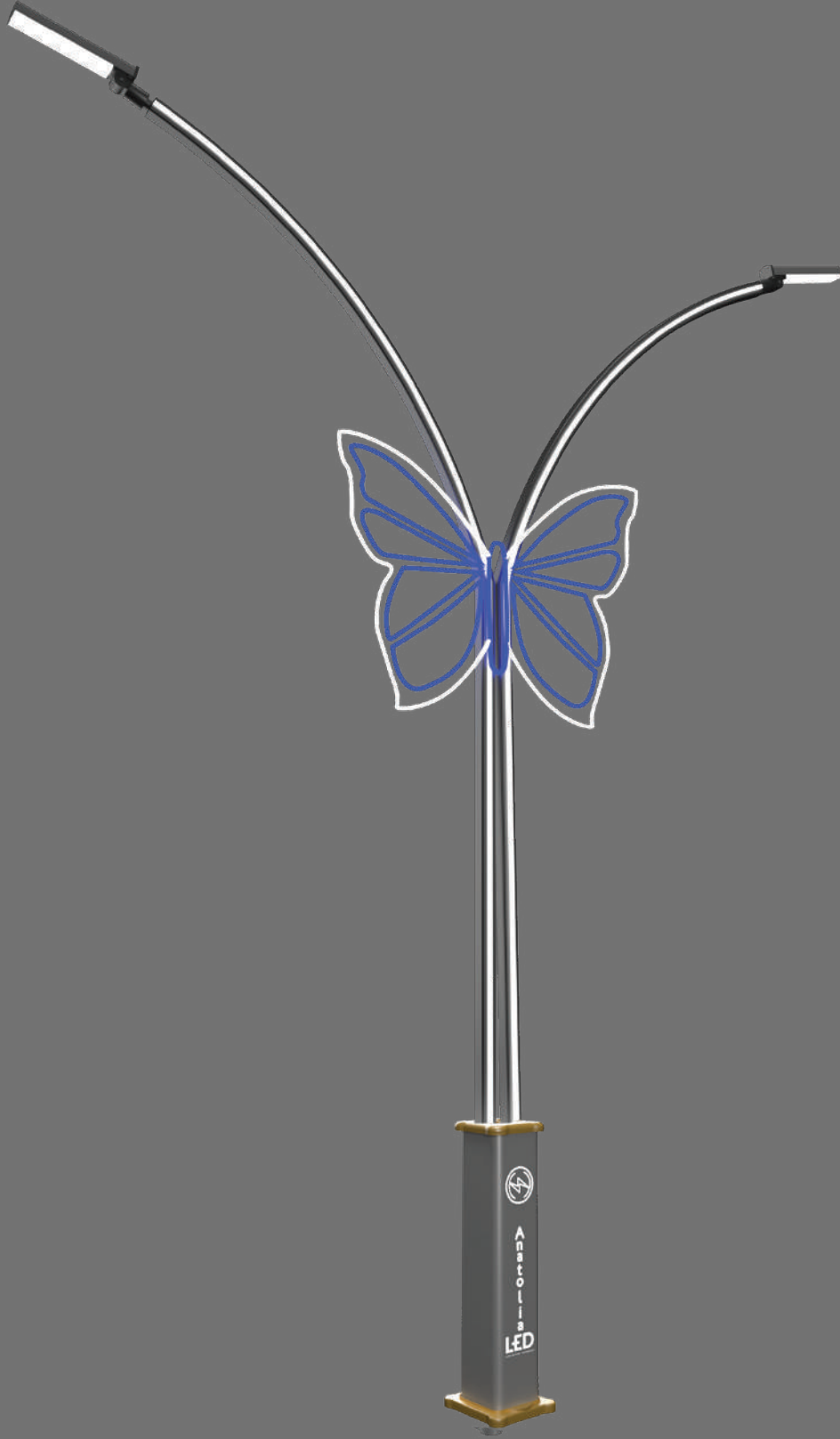

## ANATOLIA BUTTERFLY

Profil Detayı Profile Detail	Alüminyum Armatür Aluminum Armature	Armatür Kapak Armature Cover	Gövde Body	Kaide Tipi Base Type
			Alüminyum & Çelik Aluminium & Steel	Alüminyum & Çelik Aluminium & Steel

Şerit Led Detay  
Led Strip Detail

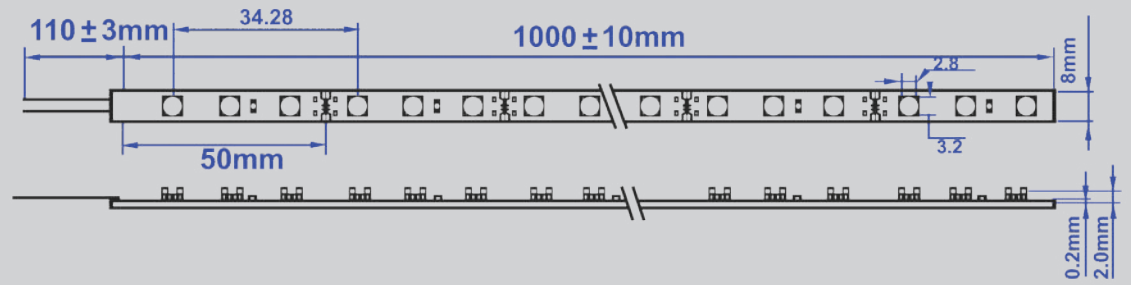

Ürün Belgeleri Product Documents			
Ürün Sertifikaları Product Certificates	TS EN 605 98-1-2 TS EN 605 98-1 TS 8700 EN 605 98-2-3	ISO 9001:2008 ISO 14001:2004 ISO 18002	OHSAS 18001:2007

**AnatoliaLED®**  
LED LIGHTING TECHNOLOGY



GRUP  
HAKÖZ®  
ENERJİ VE YATIRIM



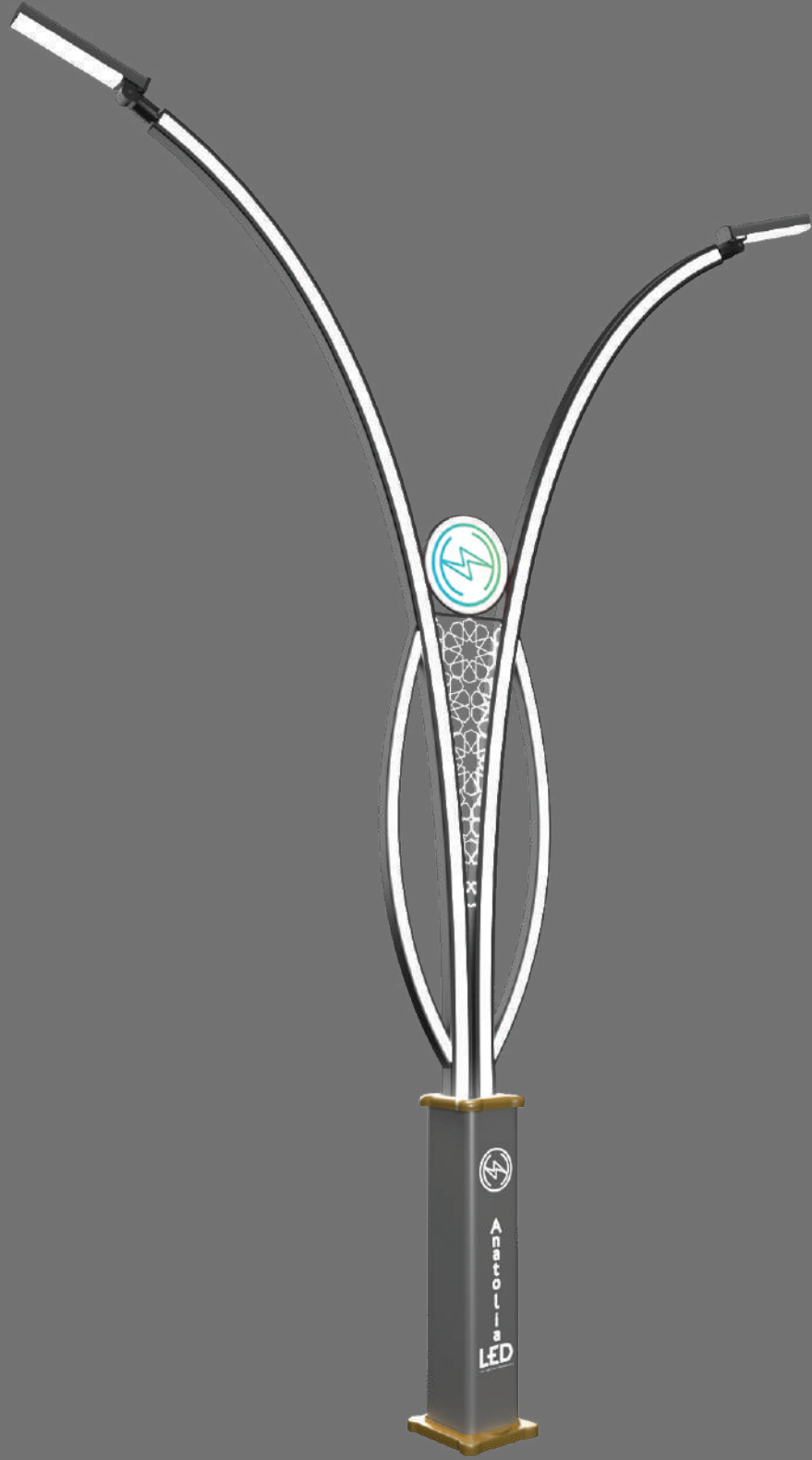

## ANATOLIA BETA

Profil Detayı Profile Detail	Alüminyum Armatür Aluminum Armature	Armatür Kapak Armature Cover	Gövde Body	Kaide Tipi Base Type
			Alüminyum & Çelik Aluminium & Steel	Alüminyum & Çelik Aluminium & Steel

Şerit Led Detay  
Led Strip Detail

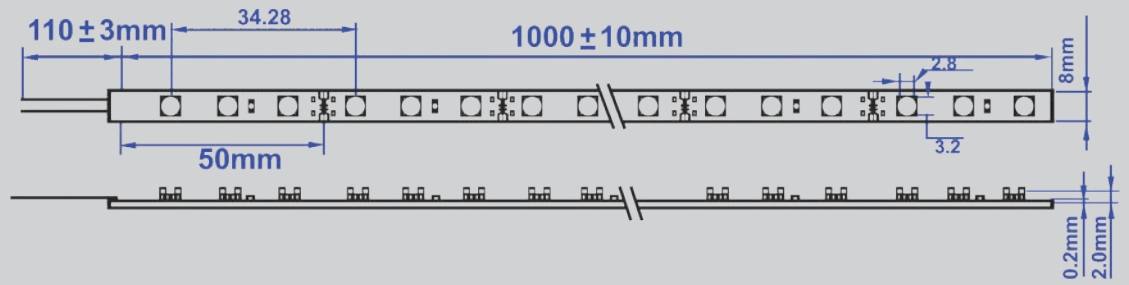

Ürün Belgeleri Product Documents			
Ürün Sertifikaları Product Certificates	TS EN 605 98-1-2 TS EN 605 98-1 TS 8700 EN 605 98-2-3	ISO 9001:2008 ISO 14001:2004 ISO 18002	OHSAS 18001:2007

**AnatoliaLED®**  
LED LIGHTING TECHNOLOGY



DEEP  
HAKÖZ®  
ILLUMINATION & ARCHITECTURE

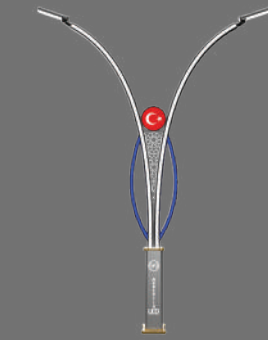
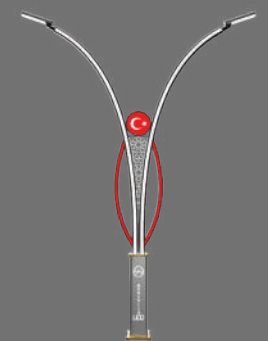
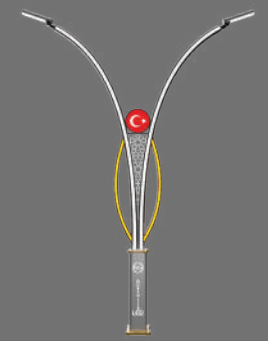

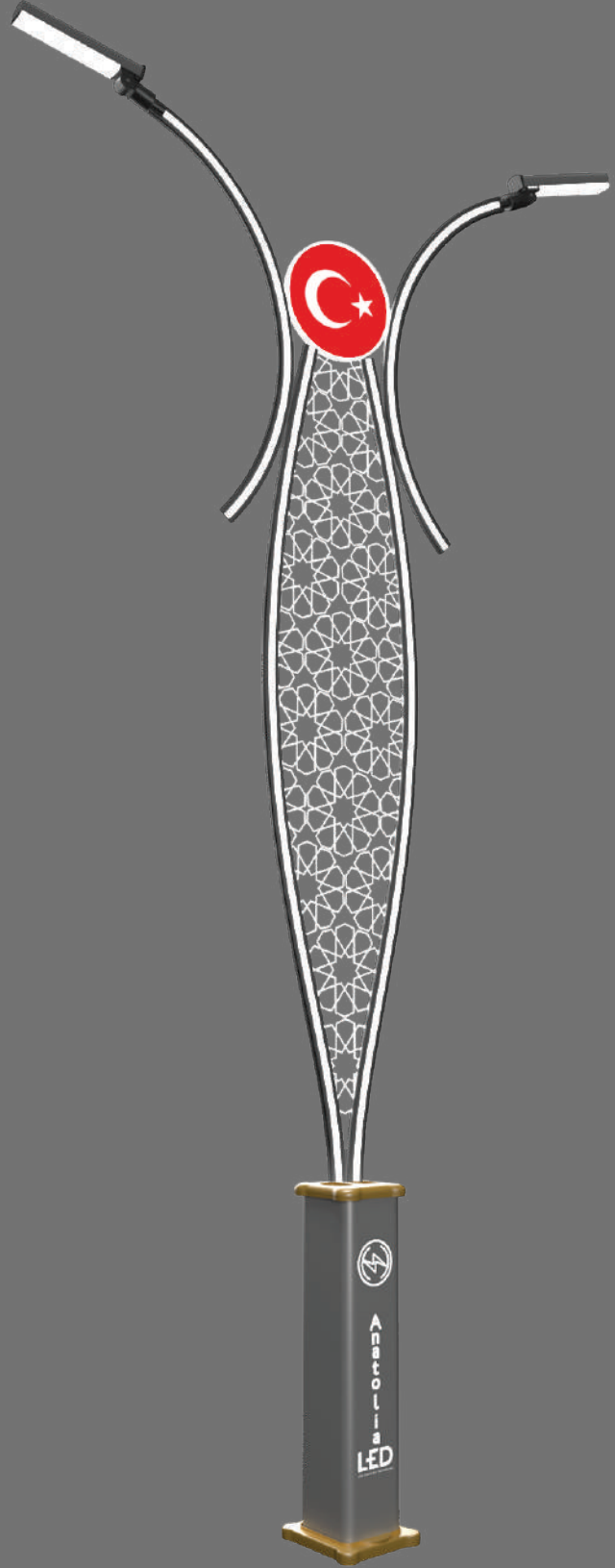

## ANATOLIA COURSE

Profil Detayı Profile Detail	Alüminyum Armatür Aluminum Armature	Armatür Kapak Armature Cover	Gövde Body	Kaide Tipi Base Type
			Alüminyum & Çelik Aluminium & Steel	Alüminyum & Çelik Aluminium & Steel

Şerit Led Detay  
Led Strip Detail

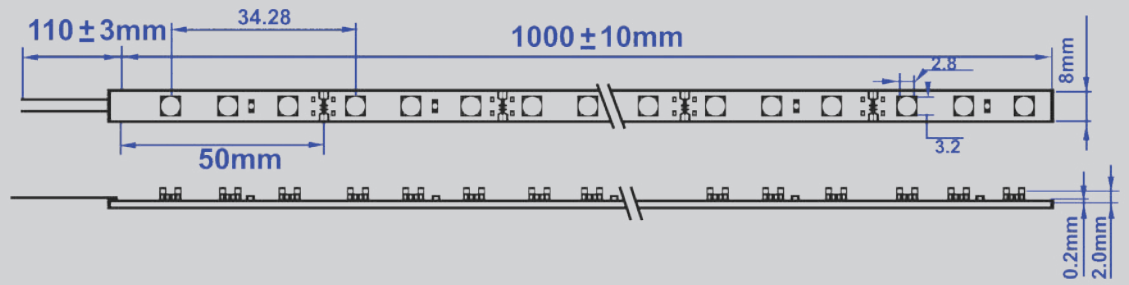

Ürün Belgeleri Product Documents			
Ürün Sertifikaları Product Certificates	TS EN 605 98-1-2 TS EN 605 98-1 TS 8700 EN 605 98-2-3	ISO 9001:2008 ISO 14001:2004 ISO 18002	OHSAS 18001:2007

**AnatoliaLED®**  
LED LIGHTING TECHNOLOGY



GRUP  
HAKÖZ®  
ENERJİ VE AYDINLATMA

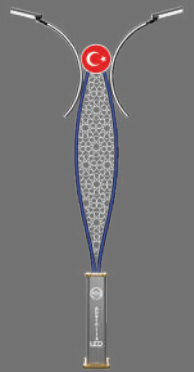
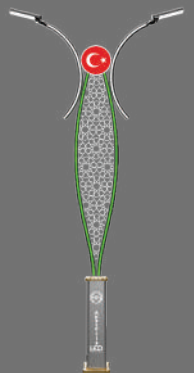
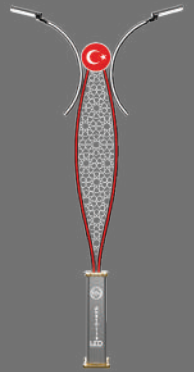

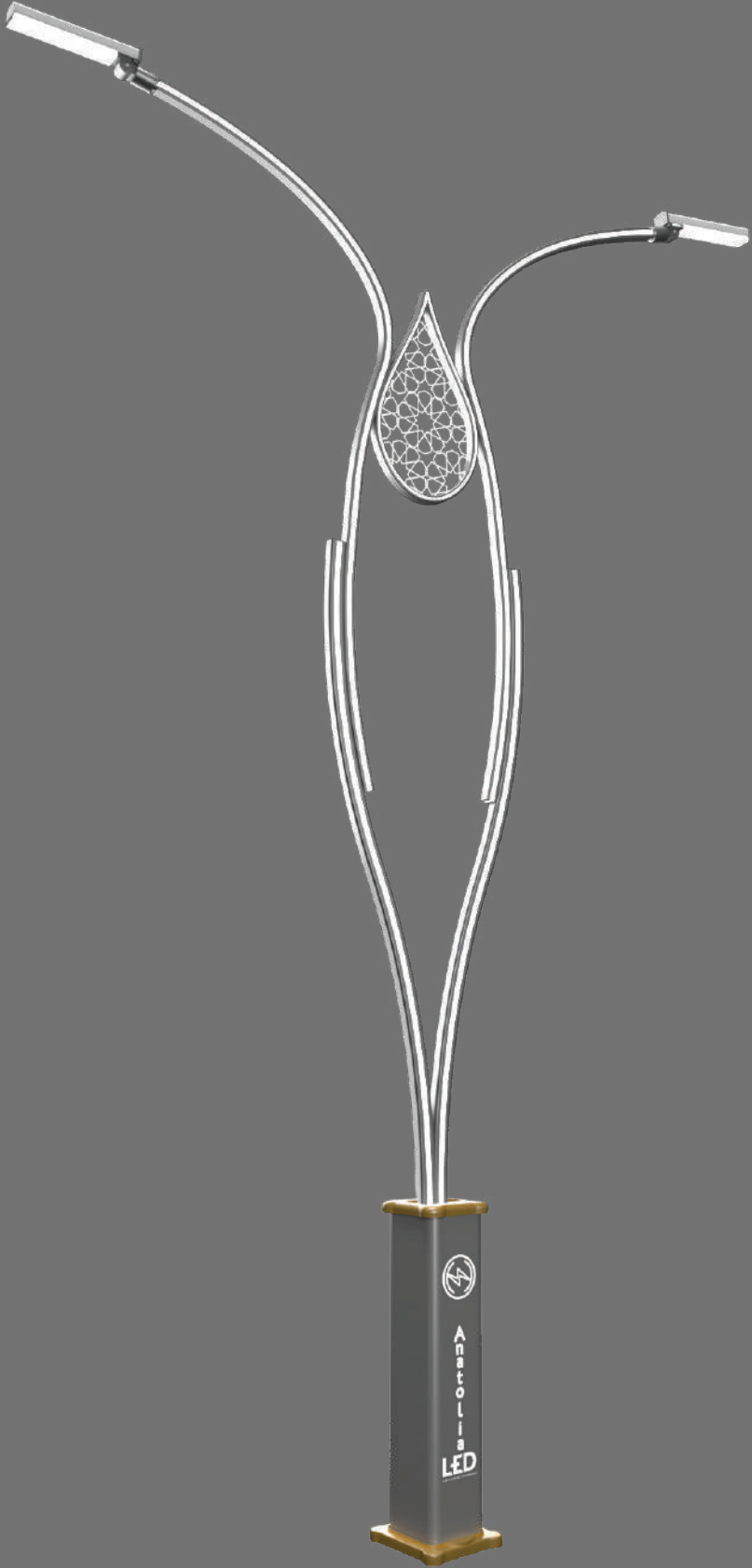

## ANATOLIA DAMLA

Profil Detayı Profile Detail	Alüminyum Armatür Aluminum Armature	Armatür Kapak Armature Cover	Gövde Body	Kaide Tipi Base Type
			Alüminyum & Çelik Aluminium & Steel	Alüminyum & Çelik Aluminium & Steel

Şerit Led Detay  
Led Strip Detail

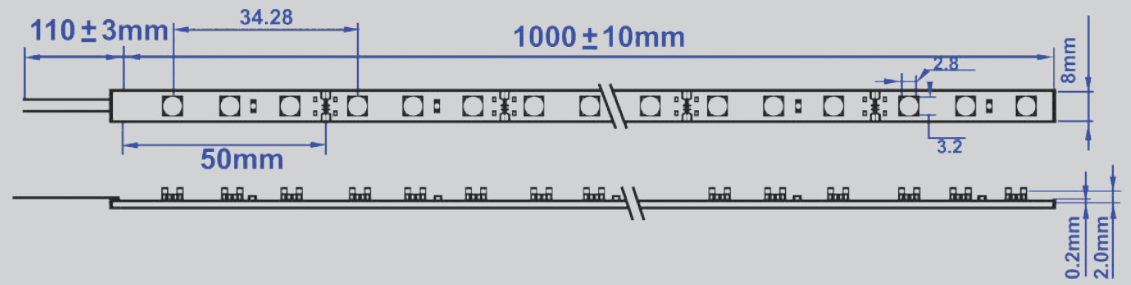

Ürün Belgeleri Product Documents			
Ürün Sertifikaları Product Certificates	TS EN 605 98-1-2 TS EN 605 98-1 TS 8700 EN 605 98-2-3	ISO 9001:2008 ISO 14001:2004 ISO 18002	OHSAS 18001:2007

**AnatoliaLED®**  
LED LIGHTING TECHNOLOGY



GRUP  
HAKÖZ®  
ENERJENİ KORUMA VE YAKARSAK

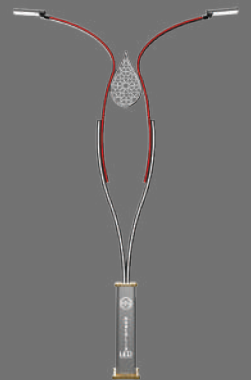
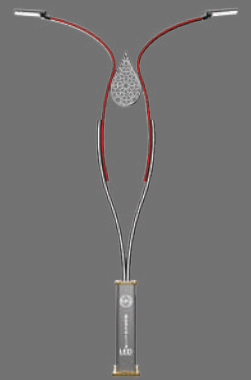

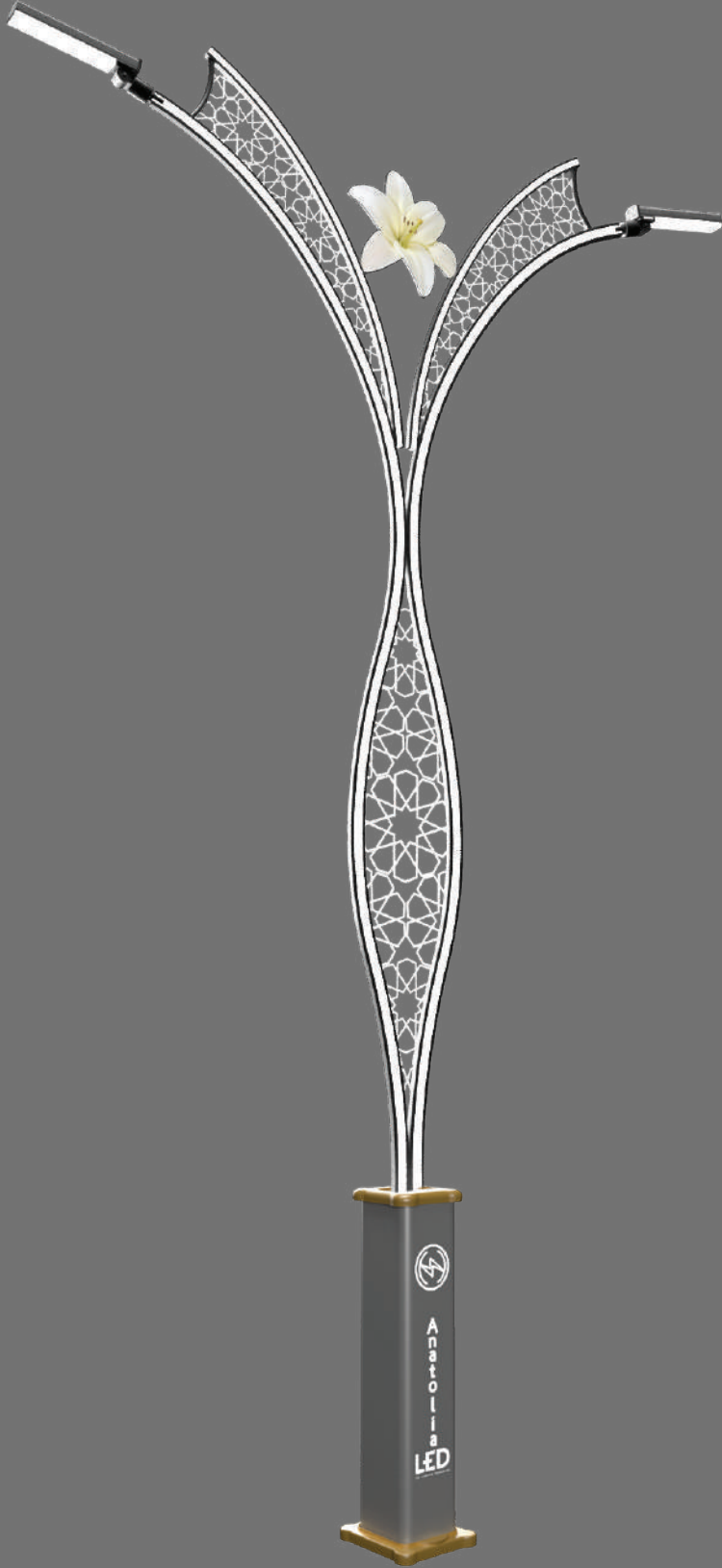

## ANATOLIA FISH

Profil Detayı Profile Detail	Alüminyum Armatür Aluminum Armature	Armatür Kapak Armature Cover	Gövde Body	Kaide Tipi Base Type
			Alüminyum & Çelik Aluminium & Steel	Alüminyum & Çelik Aluminium & Steel

Şerit Led Detay  
Led Strip Detail

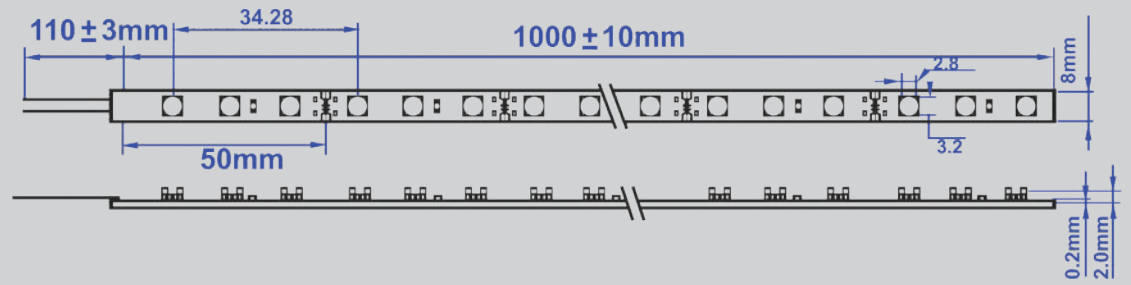

Ürün Belgeleri Product Documents			
Ürün Sertifikaları Product Certificates	TS EN 605 98-1-2 TS EN 605 98-1 TS 8700 EN 605 98-2-3	ISO 9001:2008 ISO 14001:2004 ISO 18002	OHSAS 18001:2007

**AnatoliaLED®**  
LED LIGHTING TECHNOLOGY



GRUP  
HAKÖZ®  
ENERJİLER VE ENERJİLER

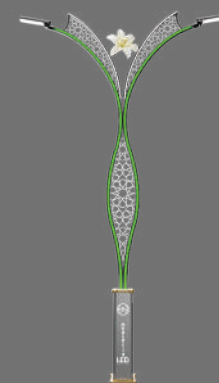
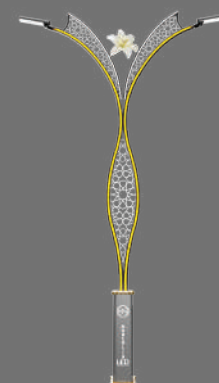
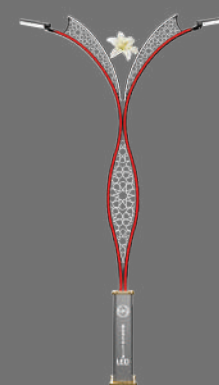

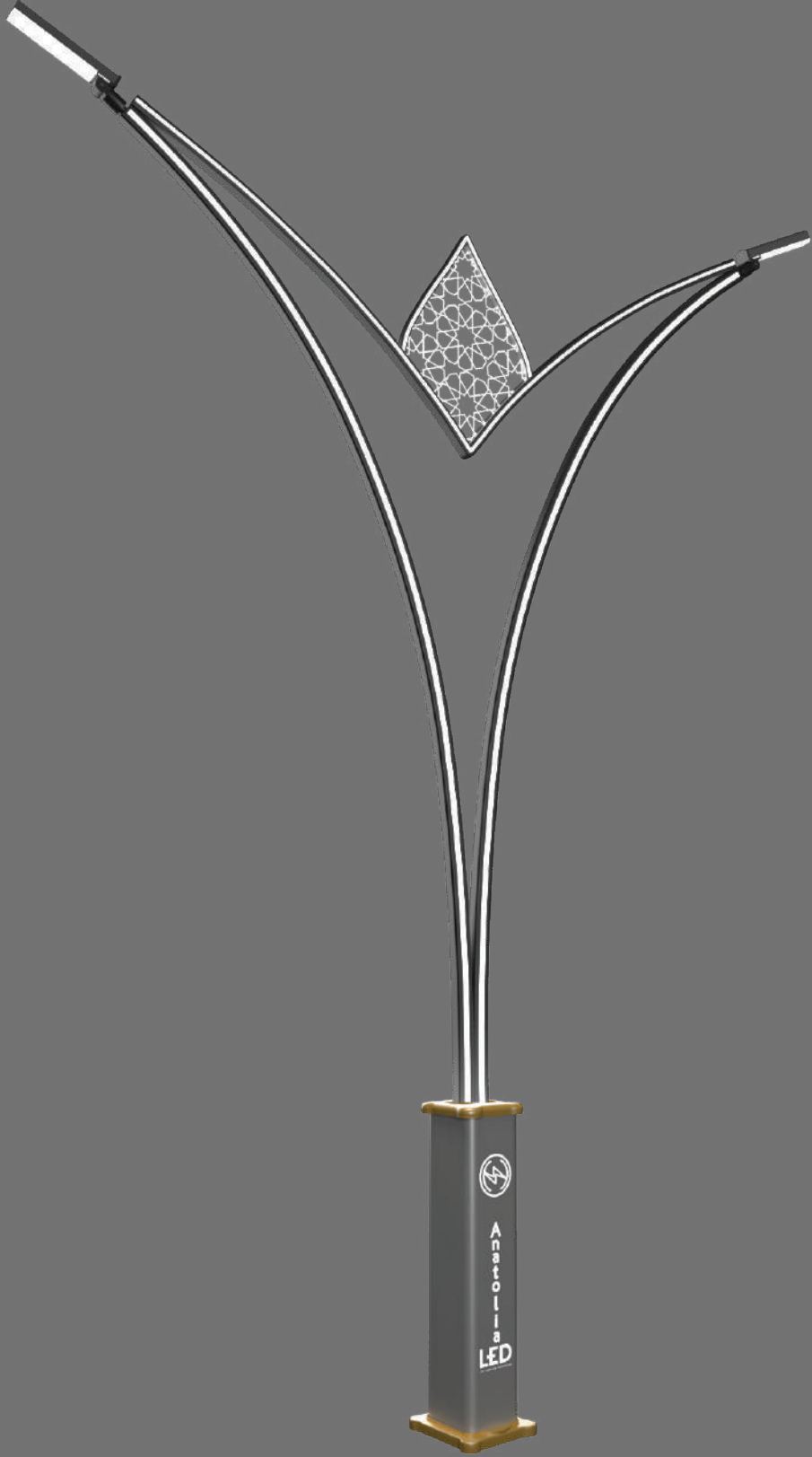

## ANATOLIA PEAK

Profil Detayı Profile Detail	Alüminyum Armatür Aluminum Armature	Armatür Kapak Armature Cover	Gövde Body	Kaide Tipi Base Type
			Alüminyum & Çelik Aluminium & Steel	Alüminyum & Çelik Aluminium & Steel

Şerit Led Detay  
Led Strip Detail

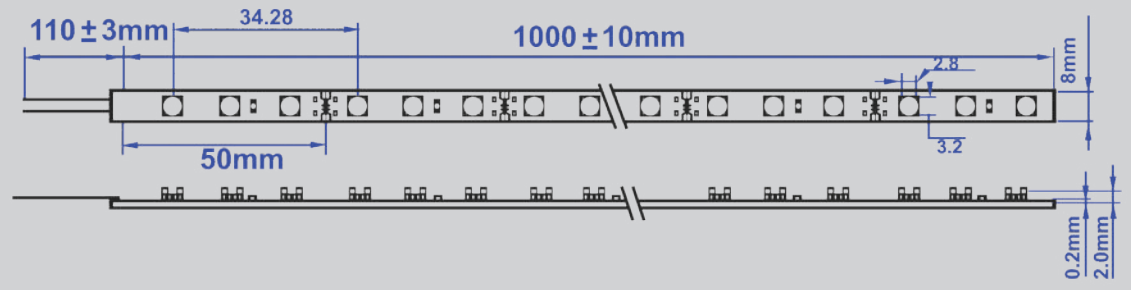

Ürün Belgeleri Product Documents			
Ürün Sertifikaları Product Certificates	TS EN 605 98-1-2 TS EN 605 98-1 TS 8700 EN 605 98-2-3	ISO 9001:2008 ISO 14001:2004 ISO 18002	OHSAS 18001:2007

**AnatoliaLED®**  
LED LIGHTING TECHNOLOGY



  
GRUP HAKÖZ®  
ENERJİ VE ENERJİ YATIRIM

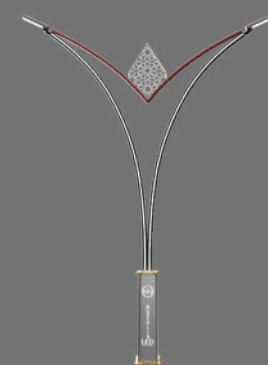
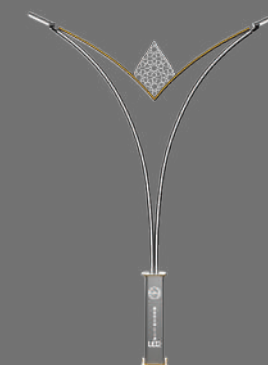
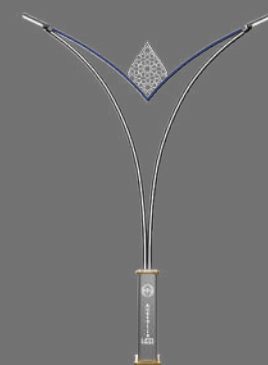

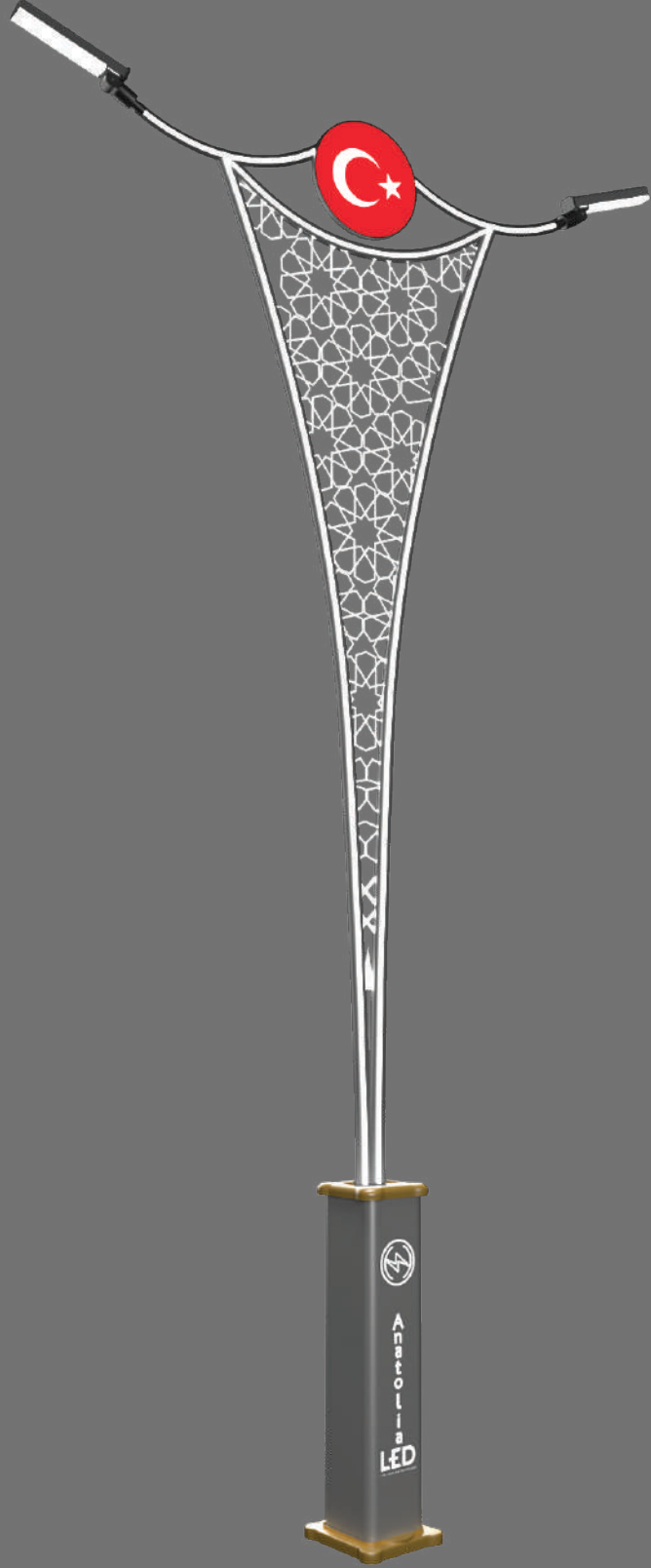

## ANATOLIA ERCİYES

Profil Detayı Profile Detail	Alüminyum Armatür Aluminum Armature	Armatür Kapak Armature Cover	Gövde Body	Kaide Tipi Base Type
			Alüminyum & Çelik Aluminium & Steel	Alüminyum & Çelik Aluminium & Steel

Şerit Led Detay  
Led Strip Detail

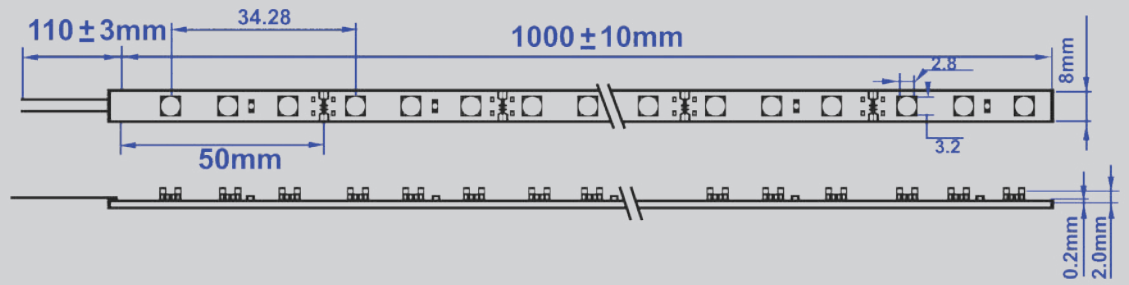

Ürün Belgeleri Product Documents			
Ürün Sertifikaları Product Certificates	TS EN 605 98-1-2 TS EN 605 98-1 TS 8700 EN 605 98-2-3	ISO 9001:2008 ISO 14001:2004 ISO 18002	OHSAS 18001:2007

**AnatoliaLED®**  
LED LIGHTING TECHNOLOGY



GRUP  
HAKÖZ®  
ENERJİ VE AYDINLATMA

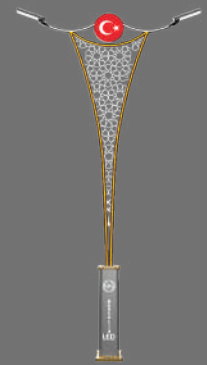



## ANATOLIA APART

Profil Detayı Profile Detail	Alüminyum Armatür Aluminum Armature	Armatür Kapak Armature Cover	Gövde Body	Kaide Tipi Base Type
			Alüminyum & Çelik Aluminium & Steel	Alüminyum & Çelik Aluminium & Steel

### Şerit Led Detay Led Strip Detail

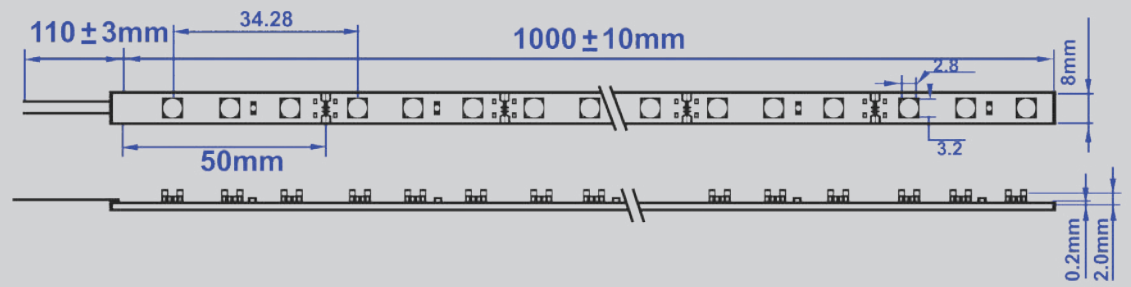

Ürün Belgeleri Product Documents			
Ürün Sertifikaları Product Certificates	TS EN 605 98-1-2 TS EN 605 98-1 TS 8700 EN 605 98-2-3	ISO 9001:2008 ISO 14001:2004 ISO 18002	OHSAS 18001:2007

**AnatoliaLED®**  
LED LIGHTING TECHNOLOGY



GRUP  
**HAKOZ**<sup>®</sup>  
ENERJİ VE ENERJİ KORUMA





## ANATOLIA ARROW

Profil Detayı Profile Detail	Alüminyum Armatür Aluminum Armature	Armatür Kapak Armature Cover	Gövde Body	Kaide Tipi Base Type
			Alüminyum & Çelik Aluminium & Steel	Alüminyum & Çelik Aluminium & Steel

Şerit Led Detay  
Led Strip Detail

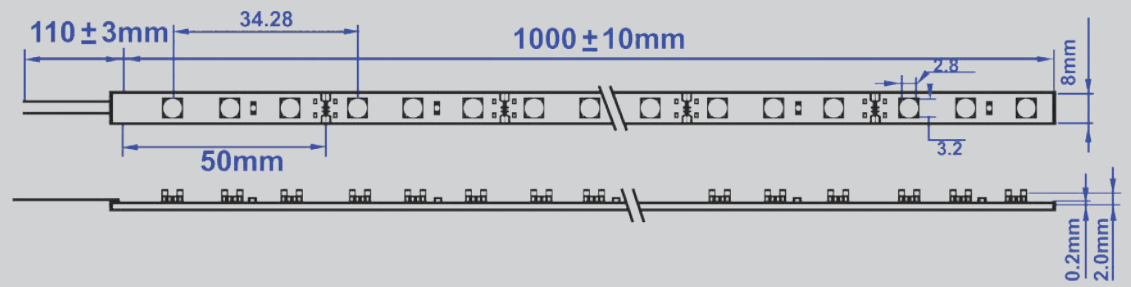

Ürün Belgeleri Product Documents			
Ürün Sertifikaları Product Certificates	TS EN 605 98-1-2 TS EN 605 98-1 TS 8700 EN 605 98-2-3	ISO 9001:2008 ISO 14001:2004 ISO 18002	OHSAS 18001:2007

**AnatoliaLED®**  
LED LIGHTING TECHNOLOGY



GRUP  
**HAKÖZ**  
ENERJİ VE AYDINLATMA

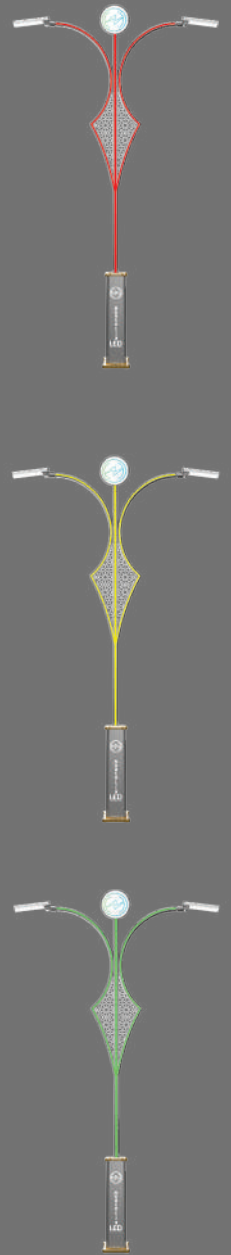



## ANATOLIA PALM

Profil Detayı Profile Detail	Alüminyum Armatür Aluminum Armature	Armatür Kapak Armature Cover	Gövde Body	Kaide Tipi Base Type
			Alüminyum & Çelik Aluminium & Steel	Alüminyum & Çelik Aluminium & Steel

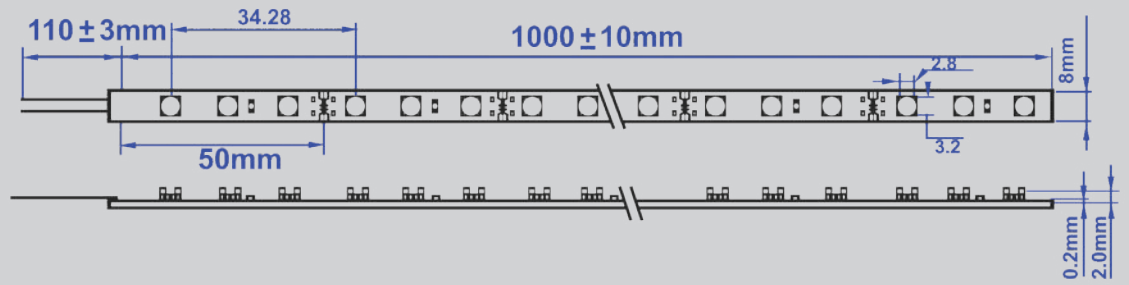
Şerit Led Detay  
Led Strip Detail



Ürün Belgeleri Product Documents			
Ürün Sertifikaları Product Certificates	TS EN 605 98-1-2 TS EN 605 98-1 TS 8700 EN 605 98-2-3	ISO 9001:2008 ISO 14001:2004 ISO 18002	OHSAS 18001:2007

**AnatoliaLED®**  
LED LIGHTING TECHNOLOGY



HAKÖZ®  
HAKÖZ & HAKÖZ

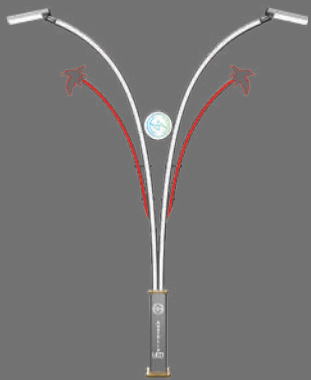
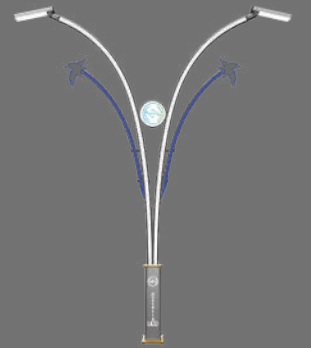

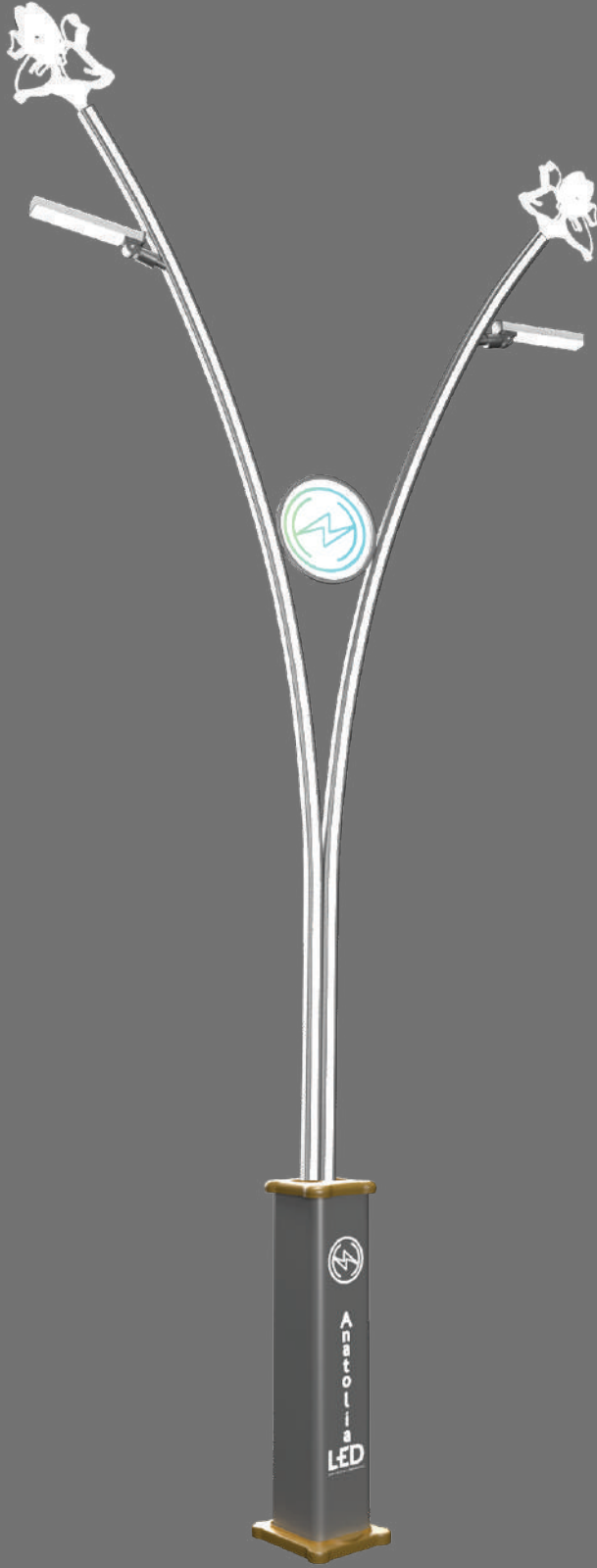

## ANATOLIA FREE

Profil Detayı Profile Detail	Alüminyum Armatür Aluminum Armature	Armatür Kapak Armature Cover	Gövde Body	Kaide Tipi Base Type
			Alüminyum & Çelik Aluminium & Steel	Alüminyum & Çelik Aluminium & Steel

Şerit Led Detay  
Led Strip Detail

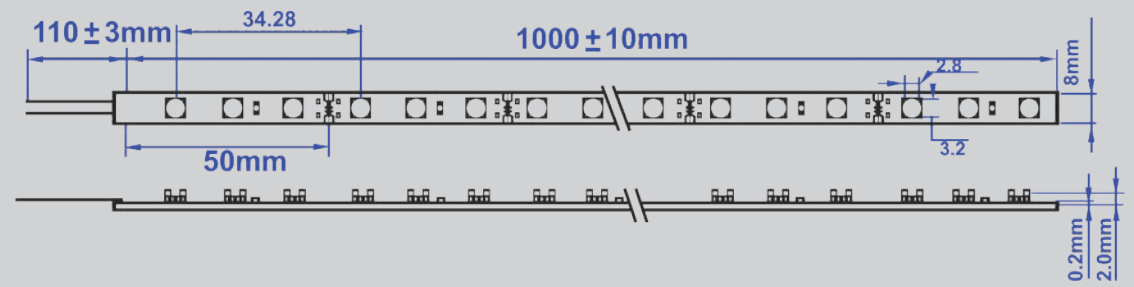

Ürün Belgeleri Product Documents			
Ürün Sertifikaları Product Certificates	TS EN 605 98-1-2 TS EN 605 98-1 TS 8700 EN 605 98-2-3	ISO 9001:2008 ISO 14001:2004 ISO 18002	OHSAS 18001:2007

**AnatoliaLED®**  
LED LIGHTING TECHNOLOGY

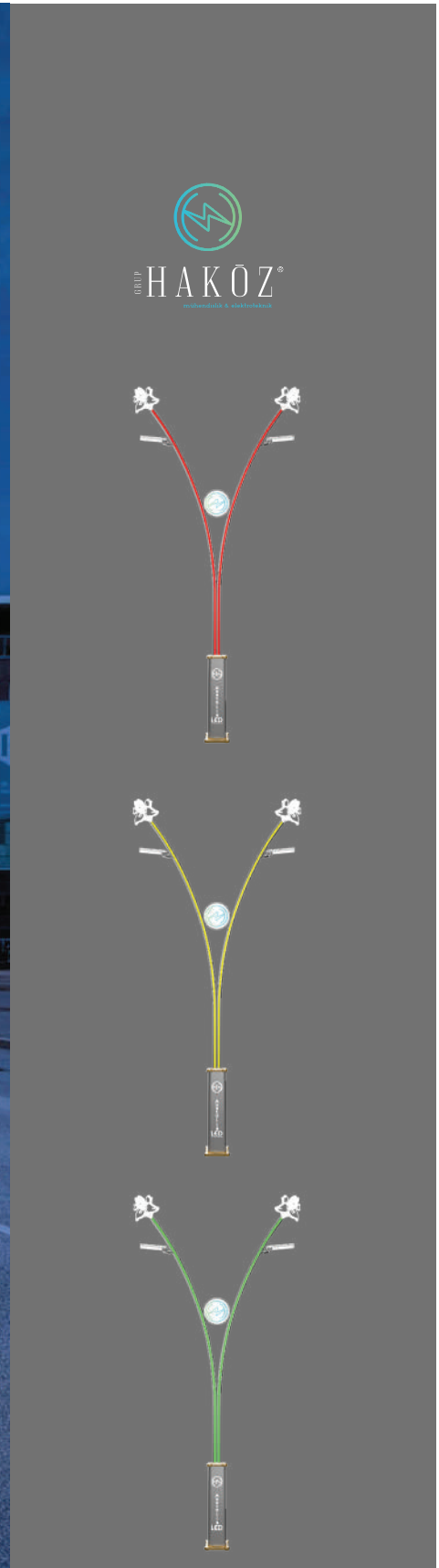

GRUP  
**HAKÖZ**  
ENERJİNİ KORU



## ANATOLIA JUMP

Profil Detayı Profile Detail	Alüminyum Armatür Aluminum Armature	Armatür Kapak Armature Cover	Gövde Body	Kaide Tipi Base Type
			Alüminyum & Çelik Aluminium & Steel	Alüminyum & Çelik Aluminium & Steel

Şerit Led Detay  
Led Strip Detail

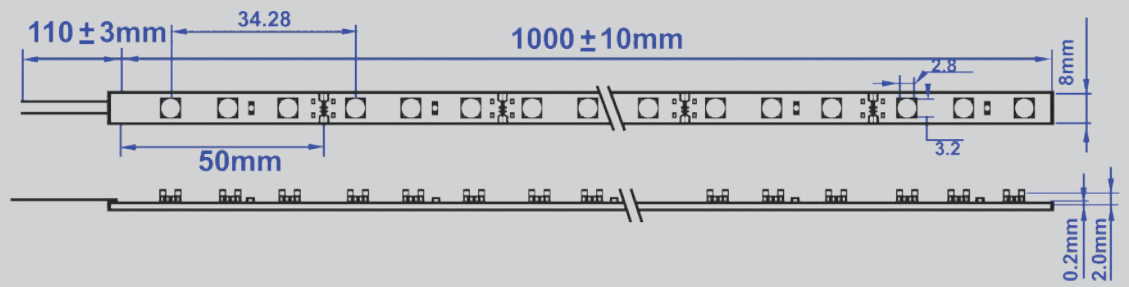

Ürün Belgeleri Product Documents			
Ürün Sertifikaları Product Certificates	TS EN 605 98-1-2 TS EN 605 98-1 TS 8700 EN 605 98-2-3	ISO 9001:2008 ISO 14001:2004 ISO 18002	OHSAS 18001:2007

**AnatoliaLED®**  
LED LIGHTING TECHNOLOGY



GRUP HAKÖZ®  
HAKÖZ HAKÖZ HAKÖZ

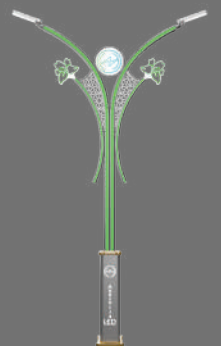

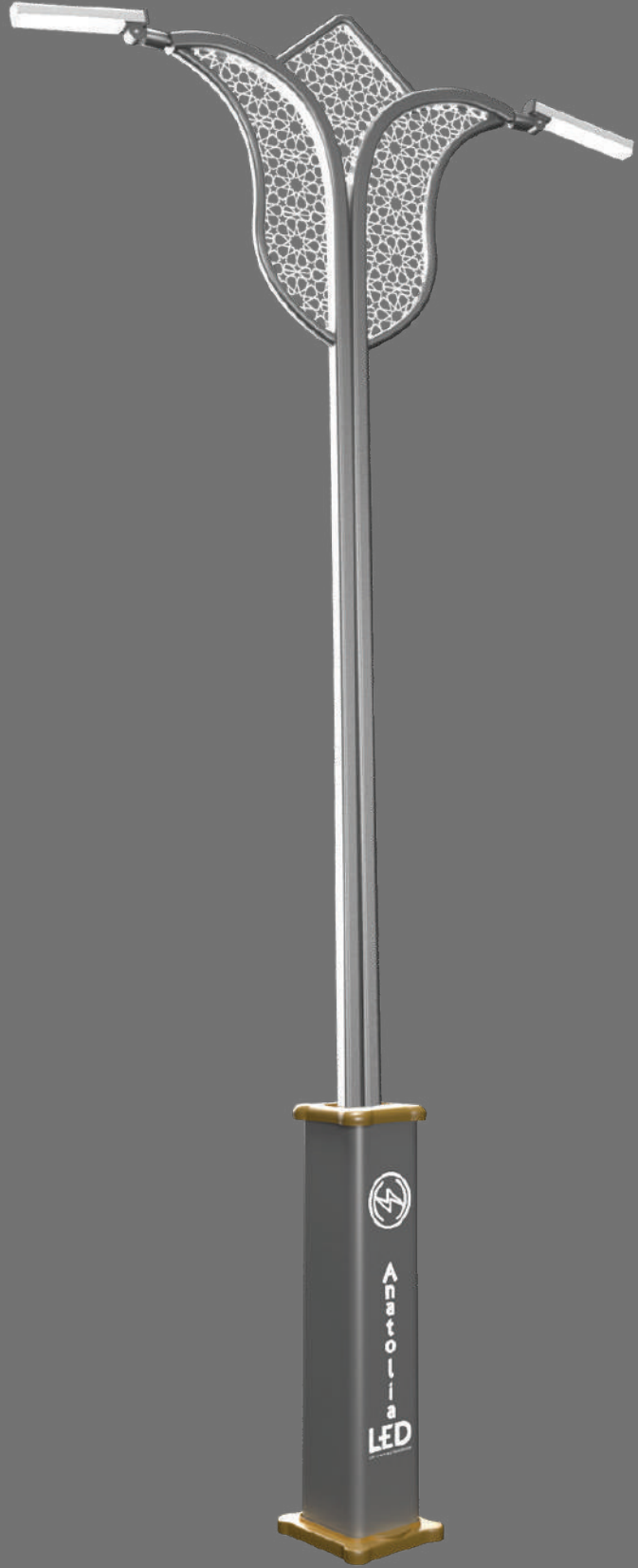

## ANATOLIA LALE

Profil Detayı Profile Detail	Alüminyum Armatür Aluminum Armature	Armatür Kapak Armature Cover	Gövde Body	Kaide Tipi Base Type
			Alüminyum & Çelik Aluminium & Steel	Alüminyum & Çelik Aluminium & Steel

Şerit Led Detay  
Led Strip Detail

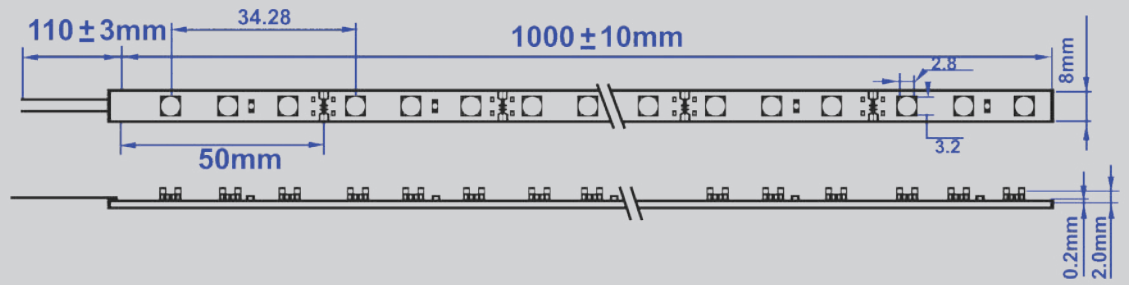

Ürün Belgeleri Product Documents			
Ürün Sertifikaları Product Certificates	TS EN 605 98-1-2 TS EN 605 98-1 TS 8700 EN 605 98-2-3	ISO 9001:2008 ISO 14001:2004 ISO 18002	OHSAS 18001:2007

**AnatoliaLED®**  
LED LIGHTING TECHNOLOGY



HAKÖZ®  
HAYATINIZI KORUYAN ENERJİ





## ANATOLIA POLY

Profil Detayı Profile Detail	Alüminyum Armatür Aluminum Armature	Armatür Kapak Armature Cover	Gövde Body	Kaide Tipi Base Type
			Alüminyum & Çelik Aluminium & Steel	Alüminyum & Çelik Aluminium & Steel

Şerit Led Detay  
Led Strip Detail

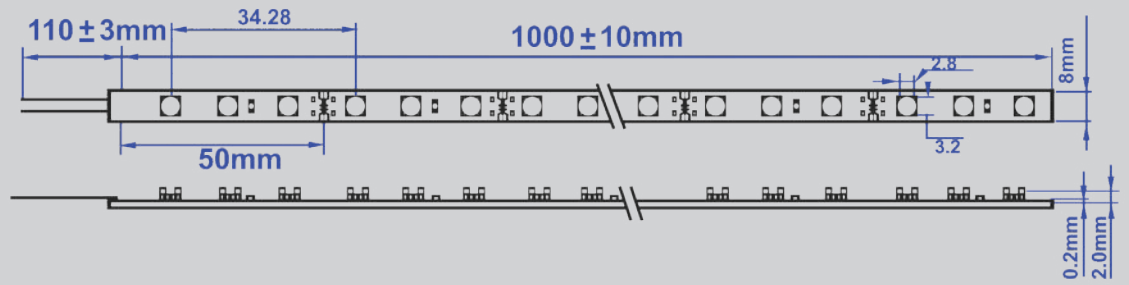

Ürün Belgeleri Product Documents			
Ürün Sertifikaları Product Certificates	TS EN 605 98-1-2 TS EN 605 98-1 TS 8700 EN 605 98-2-3	ISO 9001:2008 ISO 14001:2004 ISO 18002	OHSAS 18001:2007

**AnatoliaLED®**  
LED LIGHTING TECHNOLOGY



GRUP  
**HAKOZ**<sup>®</sup>  
ENERJİSİZ VE AKILLİ KÜLTÜR

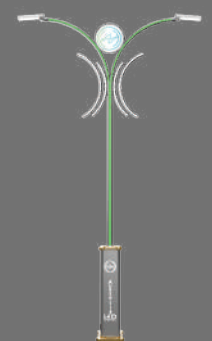
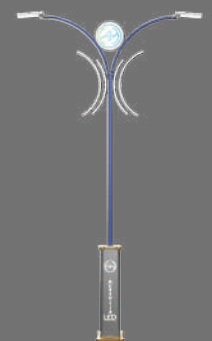
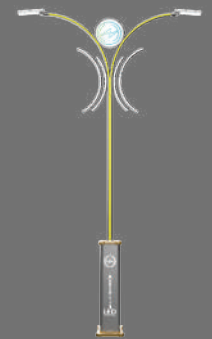

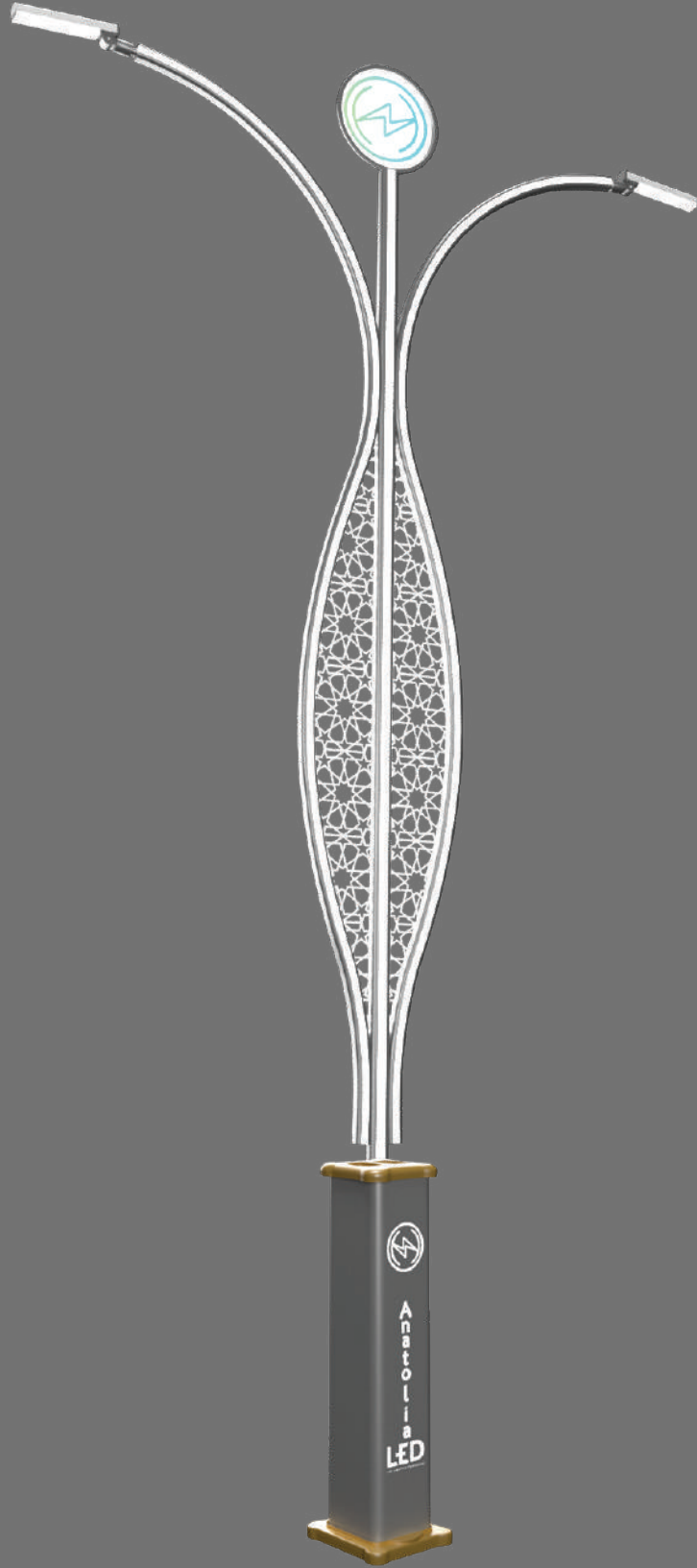

## ANATOLIA ROMMY

Profil Detayı Profile Detail	Alüminyum Armatür Aluminum Armature	Armatür Kapak Armature Cover	Gövde Body	Kaide Tipi Base Type
			Alüminyum & Çelik Aluminium & Steel	Alüminyum & Çelik Aluminium & Steel

Şerit Led Detay  
Led Strip Detail

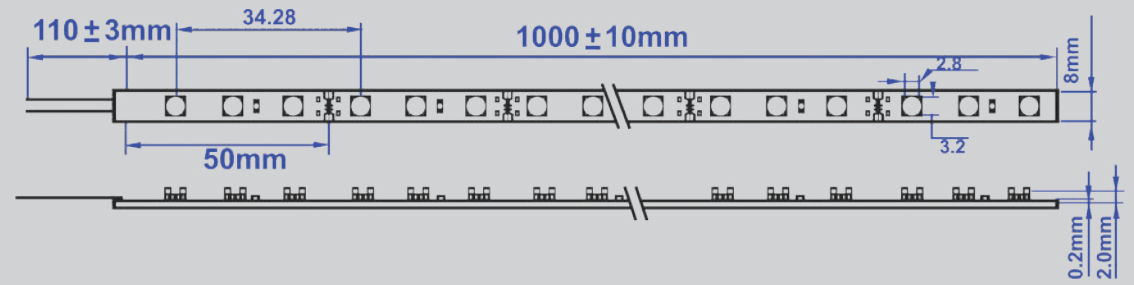

Ürün Belgeleri Product Documents			
Ürün Sertifikaları Product Certificates	TS EN 605 98-1-2 TS EN 605 98-1 TS 8700 EN 605 98-2-3	ISO 9001:2008 ISO 14001:2004 ISO 18002	OHSAS 18001:2007

**AnatoliaLED®**  
LED LIGHTING TECHNOLOGY



GRUP  
**HAKÖZ**<sup>®</sup>  
ENERJİ VE AYDINLATMA

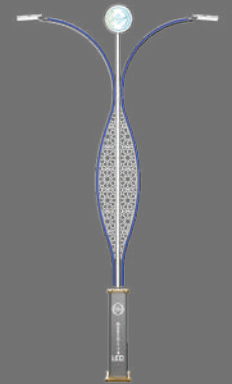
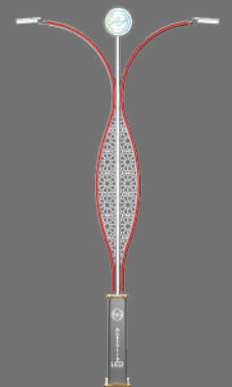
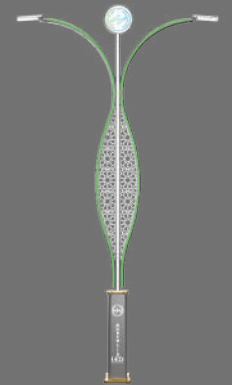

Park &  
Bahçe  
Aydınlatma  
Grubu

Park &  
Garden  
Lighting  
Group

Anatolia LED®





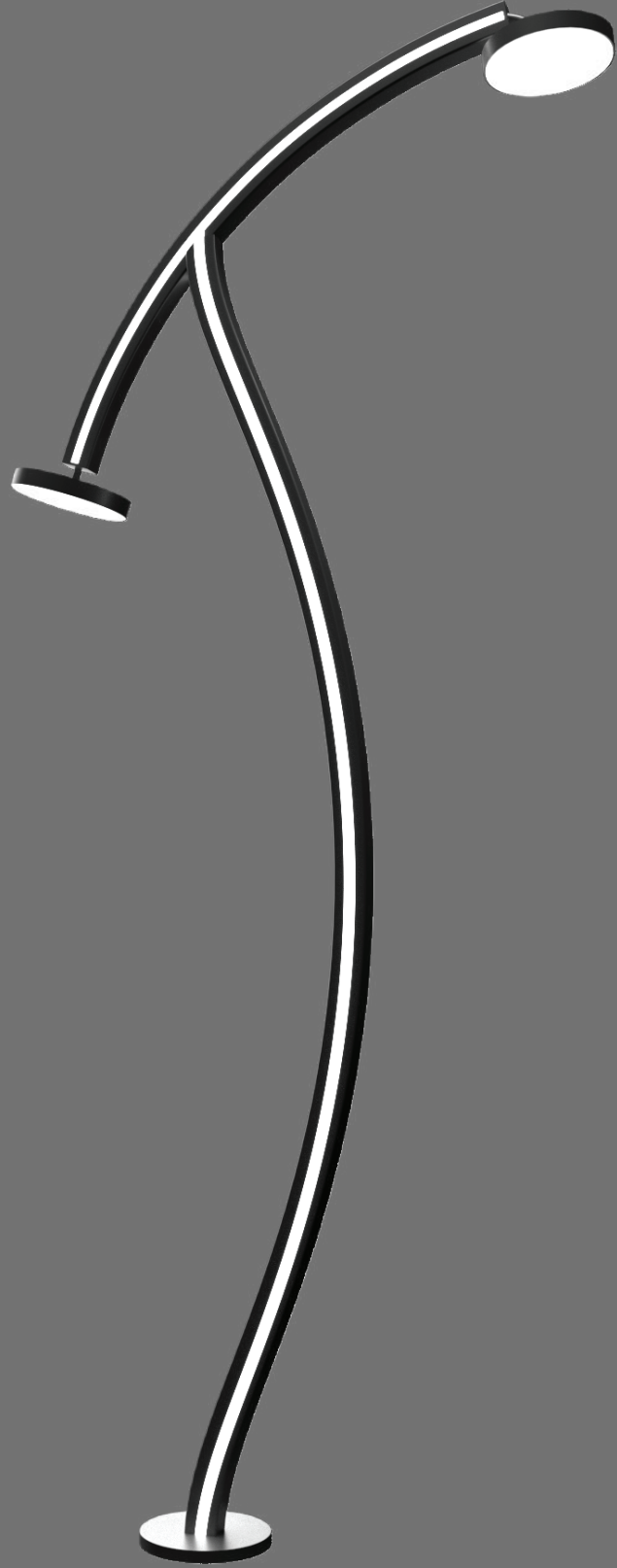

## ANATOLIA CURVE

Profil Detayı Profile Detail	Armatür Armature	Gövde Body	Kaide Tipi Base Type
		Alüminyum & Çelik Aluminium & Steel	Alüminyum & Çelik Aluminium & Steel
Şerit Led Detay Led Strip Detail			
Ürün Belgeleri Product Documents			
Ürün Sertifikaları Product Certificates	TS EN 605 98-1-2 TS EN 605 98-1 TS 8700 EN 605 98-2-3	ISO 9001:2008 ISO 14001:2004 ISO 18002	OHSAS 18001:2007

**AnatoliaLED®**  
LED LIGHTING TECHNOLOGY



GRUP  
HAKÖZ®  
MÜHÜRÜMÜZÜN KALİTESİ

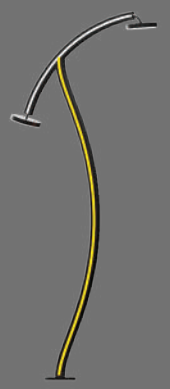
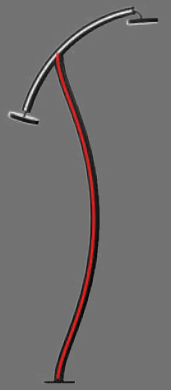



## ANATOLIA FLOWER

Profil Detayı Profile Detail	Armatür Armature	Gövde Body	Kaide Tipi Base Type
		Alüminyum & Çelik Aluminium & Steel	Alüminyum & Çelik Aluminium & Steel

### Şerit Led Detay Led Strip Detail

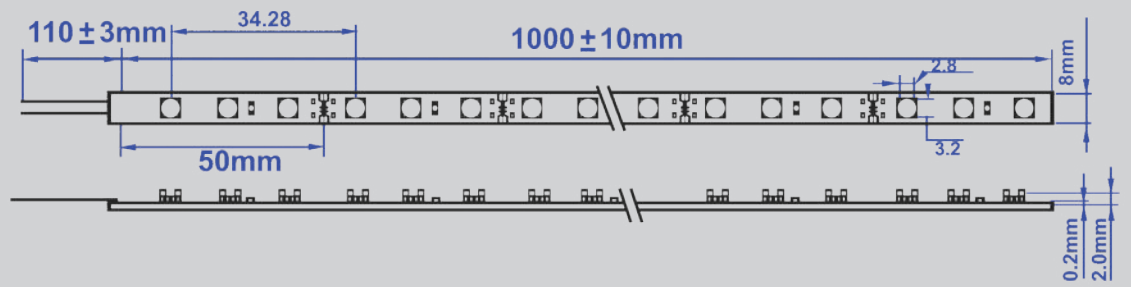

Ürün Belgeleri Product Documents			
Ürün Sertifikaları Product Certificates	TS EN 605 98-1-2 TS EN 605 98-1 TS 8700 EN 605 98-2-3	ISO 9001:2008 ISO 14001:2004 ISO 18002	OHSAS 18001:2007

**AnatoliaLED®**  
LED LIGHTING TECHNOLOGY



GRUP  
**HAKÖZ**<sup>®</sup>  
ENERJENİ KORUMA VE YAKARSAKLIK



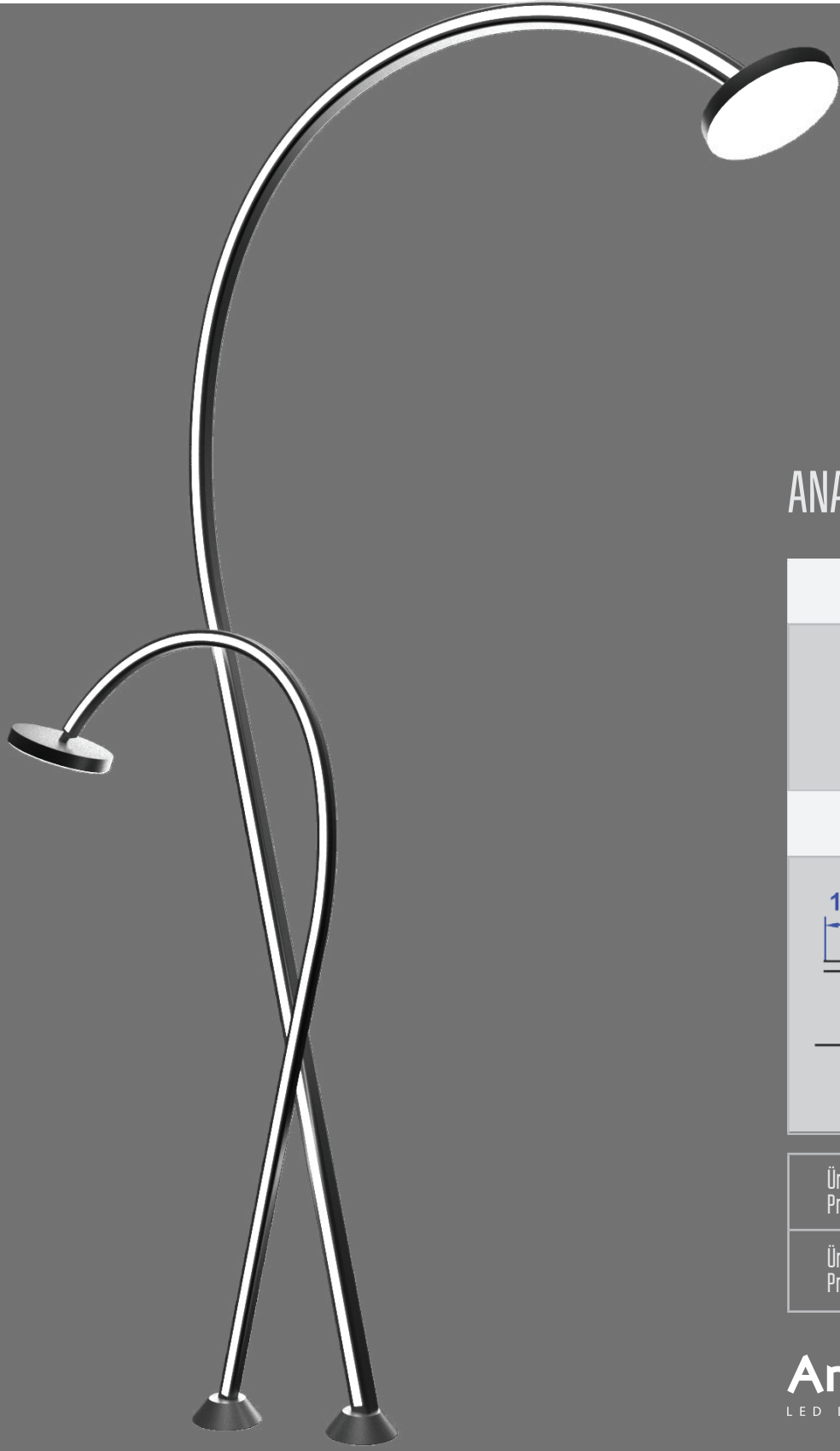

## ANATOLIA LOVE

Profil Detayı Profile Detail	Armatür Armature	Gövde Body	Kaide Tipi Base Type
		Alüminyum & Çelik Aluminium & Steel	Alüminyum & Çelik Aluminium & Steel

### Şerit Led Detay Led Strip Detail

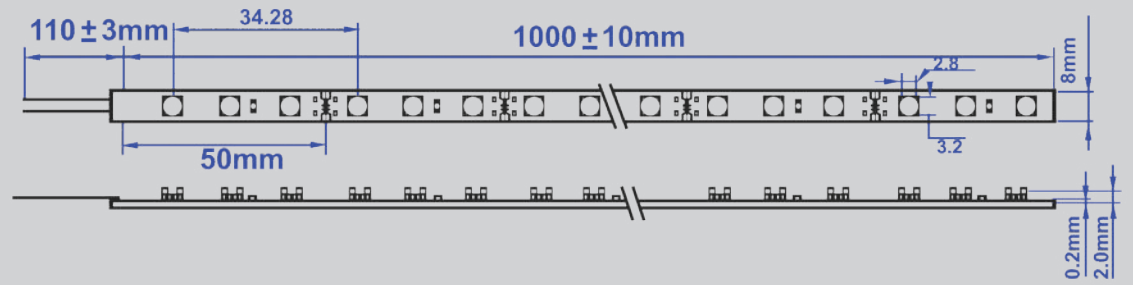

Ürün Belgeleri Product Documents			
Ürün Sertifikaları Product Certificates	TS EN 605 98-1-2 TS EN 605 98-1 TS 8700 EN 605 98-2-3	ISO 9001:2008 ISO 14001:2004 ISO 18002	OHSAS 18001:2007

**AnatoliaLED®**  
LED LIGHTING TECHNOLOGY



GRUP  
**HAKOZ**  
AYDINLATMA VE ENERJİ YÖNETİMİ

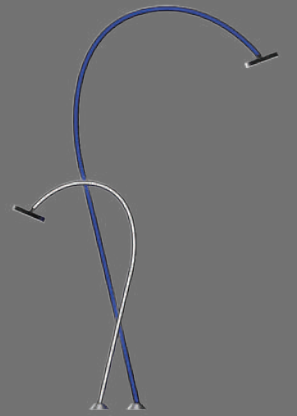
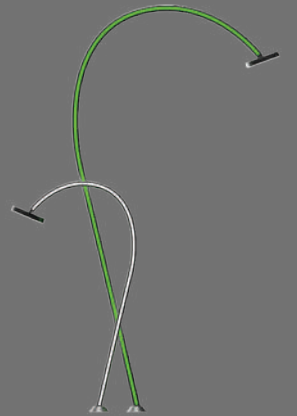
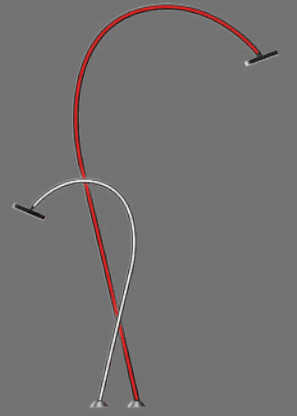

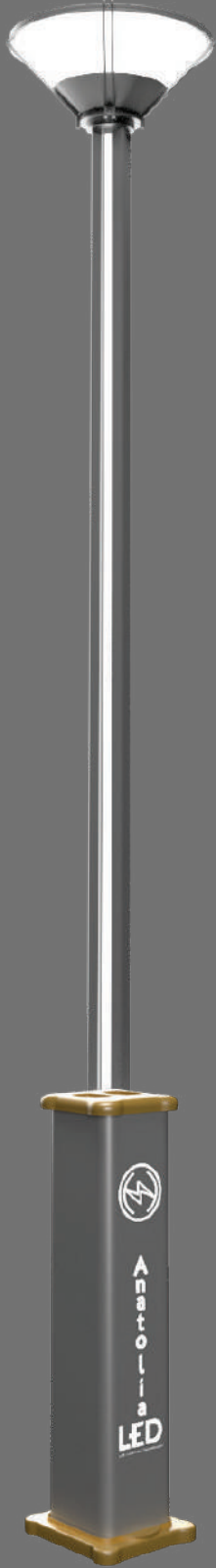

## ANATOLIA UFO

Profil Detayı Profile Detail	Armatür Armature	Gövde Body	Kaide Tipi Base Type
		Alüminyum & Çelik Aluminium & Steel	Alüminyum & Çelik Aluminium & Steel

### Şerit Led Detay Led Strip Detail

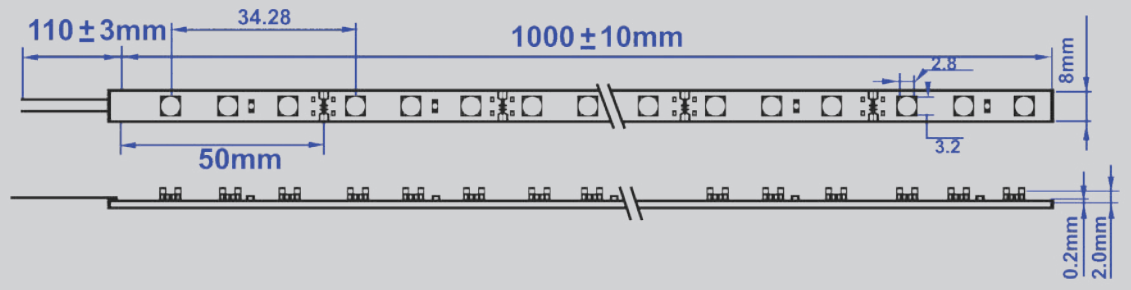

Ürün Belgeleri Product Documents			
Ürün Sertifikaları Product Certificates	TS EN 605 98-1-2 TS EN 605 98-1 TS 8700 EN 605 98-2-3	ISO 9001:2008 ISO 14001:2004 ISO 18002	OHSAS 18001:2007

**AnatoliaLED®**  
LED LIGHTING TECHNOLOGY



08117  
HAKÖZ®  
Működésük a szellemük



Kare  
Profil  
Aydınlatma  
Grubu

Square  
Profile  
Lighting  
Group

Anatolia LED®





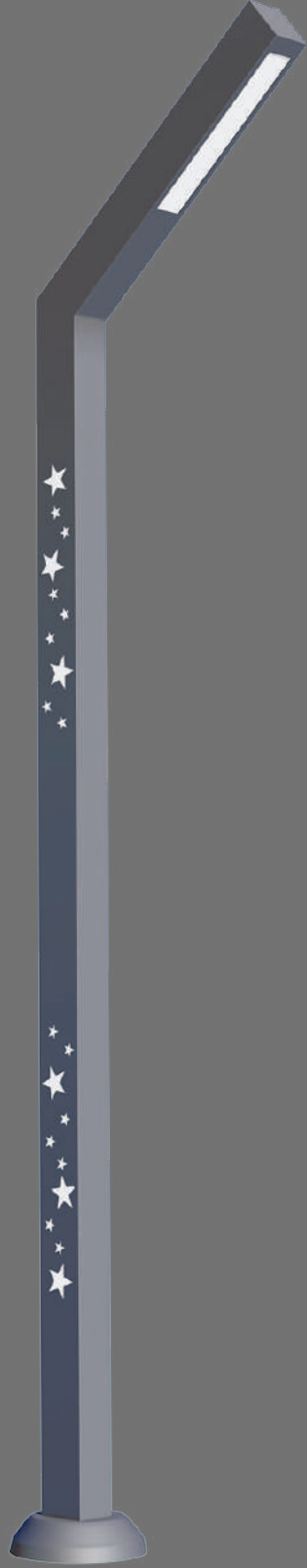

## ANATOLIA ROOFING

Profil Detayı Profile Detail	Lens Lens	Led Modül Led Module	Gövde Body	Kaide Tipi Base Type
			Çelik / Steel 40*100 Kalınlık / Thickness 1,5 mm	Alüminyum & Çelik Aluminium & Steel

Şerit Led Detayı  
Led Strip Detail

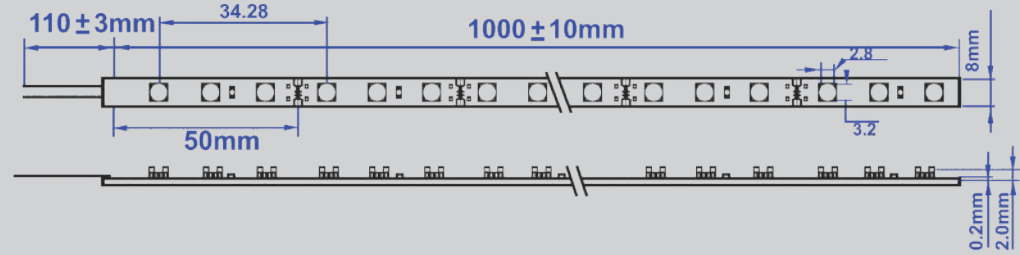

Ürün Belgeleri Product Documents			
Ürün Sertifikaları Product Certificates	TS EN 605 98-1-2 TS EN 605 98-1 TS 8700 EN 605 98-2-3	ISO 9001:2008 ISO 14001:2004 ISO 18002	OHSAS 18001:2007

**AnatoliaLED®**  
LED LIGHTING TECHNOLOGY



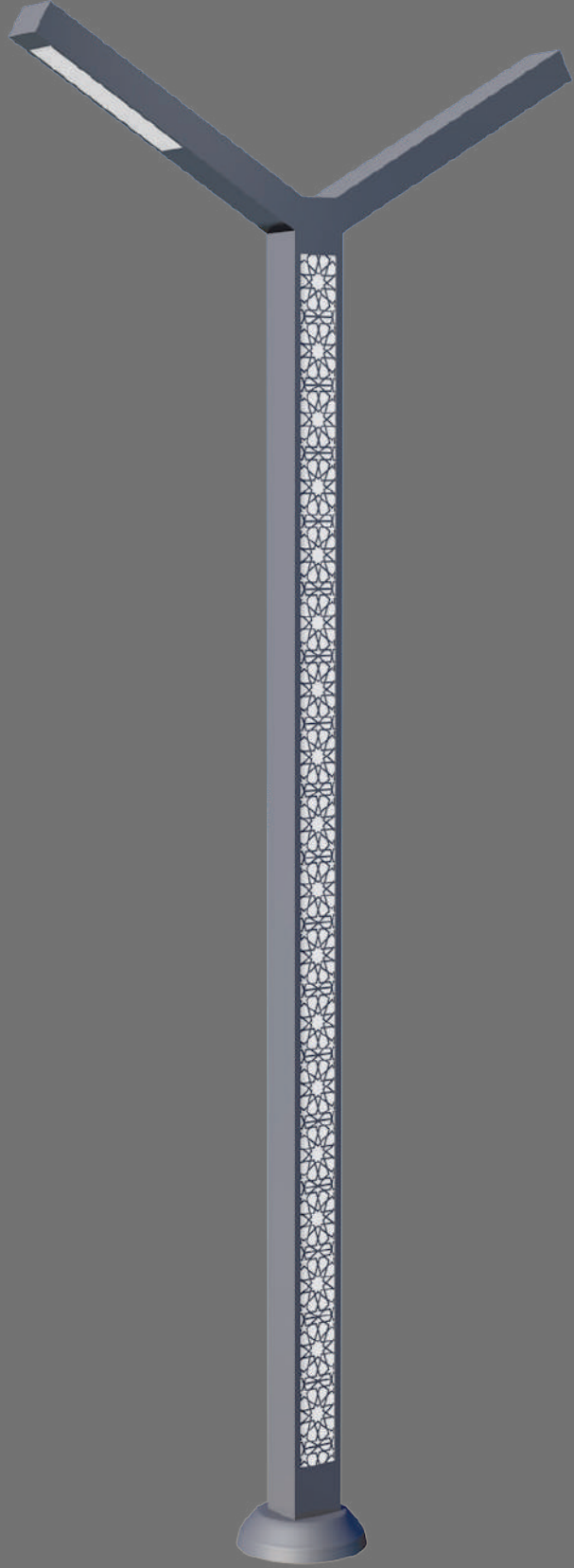

## ANATOLIA VALE

Profil Detayı Profile Detail	Lens Lens	Led Modül Led Module	Gövde Body	Kaide Tipi Base Type
			Çelik / Steel 40*100 Kalınlık / Thickness 1,5 mm	Alüminyum & Çelik Aluminium & Steel

Şerit Led Detay  
Led Strip Detail

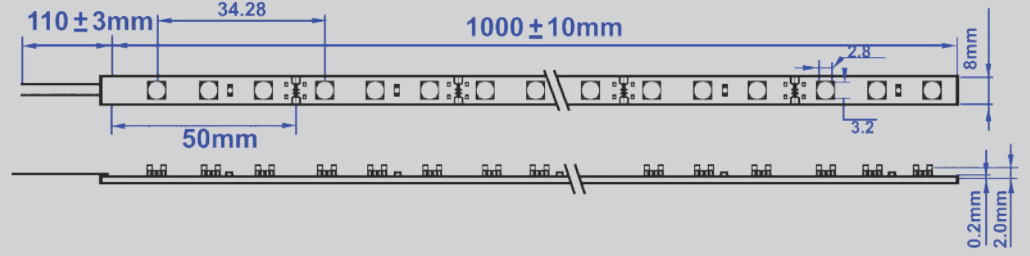

Ürün Belgeleri Product Documents			
Ürün Sertifikaları Product Certificates	TS EN 605 98-1-2 TS EN 605 98-1 TS 8700 EN 605 98-2-3	ISO 9001:2008 ISO 14001:2004 ISO 18002	OHSAS 18001:2007

**AnatoliaLED®**  
LED LIGHTING TECHNOLOGY



  
GRUP  
**HAKOZ**<sup>®</sup>  
ENERJİ VE AYDINLATMA

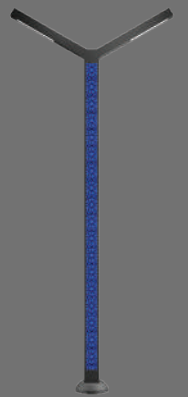
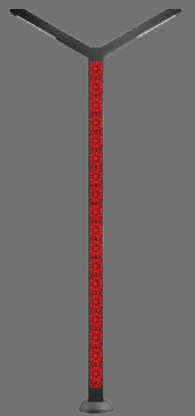
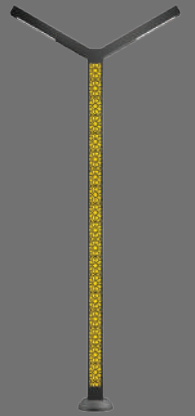



## ANATOLIA TWING

Profil Detayı Profile Detail	Lens Lens	Led Modül Led Module	Gövde Body	Kaide Tipi Base Type
			Çelik / Steel 40*100 Kalınlık / Thickness 1,5 mm	Alüminyum & Çelik Aluminium & Steel

Şerit Led Detay  
Led Strip Detail

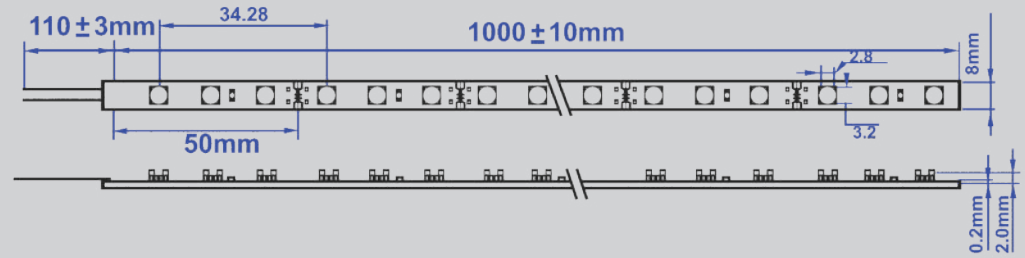

Ürün Belgeleri Product Documents			
Ürün Sertifikaları Product Certificates	TS EN 605 98-1-2 TS EN 605 98-1 TS 8700 EN 605 98-2-3	ISO 9001:2008 ISO 14001:2004 ISO 18002	OHSAS 18001:2007

**AnatoliaLED®**  
LED LIGHTING TECHNOLOGY



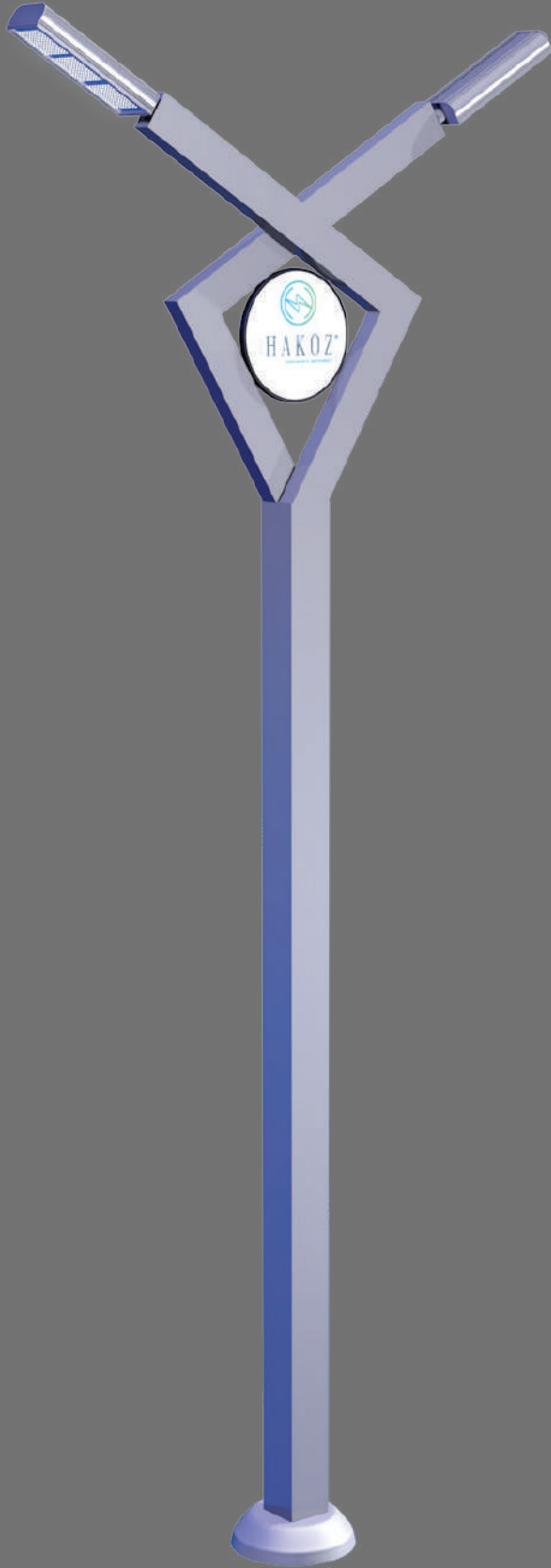

## ANATOLIA EVEREST

Profil Detayı Profile Detail	Lens Lens	Led Modül Led Module	Gövde Body	Kaide Tipi Base Type
			Çelik / Steel 40*100 Kalınlık / Thickness 1,5 mm	Alüminyum & Çelik Aluminium & Steel
Şerit Led Detayı Led Strip Detail				
Ürün Belgeleri Product Documents				
Ürün Sertifikaları Product Certificates	TS EN 605 98-1-2 TS EN 605 98-1 TS 8700 EN 605 98-2-3	ISO 9001:2008 ISO 14001:2004 ISO 18002	OHSAS 18001:2007	

**AnatoliaLED®**  
LED LIGHTING TECHNOLOGY



  
GRUP HAKOZ®  
ENERJENİ KORU





## ANATOLIA HEXAGON

Profil Detayı Profile Detail	Lens Lens	Led Modül Led Module	Gövde Body	Kaide Tipi Base Type
			Çelik / Steel 40*100 Kalınlık / Thickness 1,5 mm	Alüminyum & Çelik Aluminium & Steel

Şerit Led Detay  
Led Strip Detail

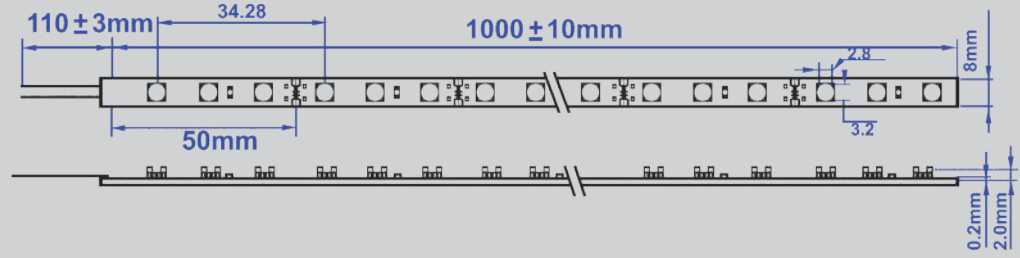

Ürün Belgeleri Product Documents			
Ürün Sertifikaları Product Certificates	TS EN 605 98-1-2 TS EN 605 98-1 TS 8700 EN 605 98-2-3	ISO 9001:2008 ISO 14001:2004 ISO 18002	OHSAS 18001:2007

**AnatoliaLED®**  
LED LIGHTING TECHNOLOGY





## ANATOLIA GAP

Profil Detayı Profile Detail	Lens Lens	Led Modül Led Module	Gövde Body	Kaide Tipi Base Type
			Çelik / Steel 40*100 Kalınlık / Thickness 1,5 mm	Alüminyum & Çelik Aluminium & Steel

Şerit Led Detay  
Led Strip Detail

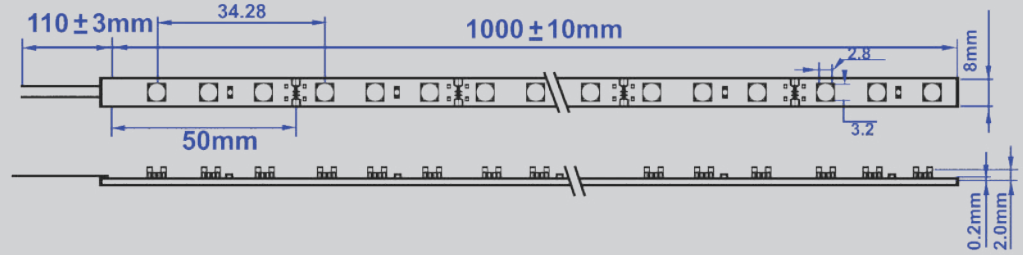

Ürün Belgeleri Product Documents			
Ürün Sertifikaları Product Certificates	TS EN 605 98-1-2 TS EN 605 98-1 TS 8700 EN 605 98-2-3	ISO 9001:2008 ISO 14001:2004 ISO 18002	OHSAS 18001:2007

**AnatoliaLED®**  
LED LIGHTING TECHNOLOGY



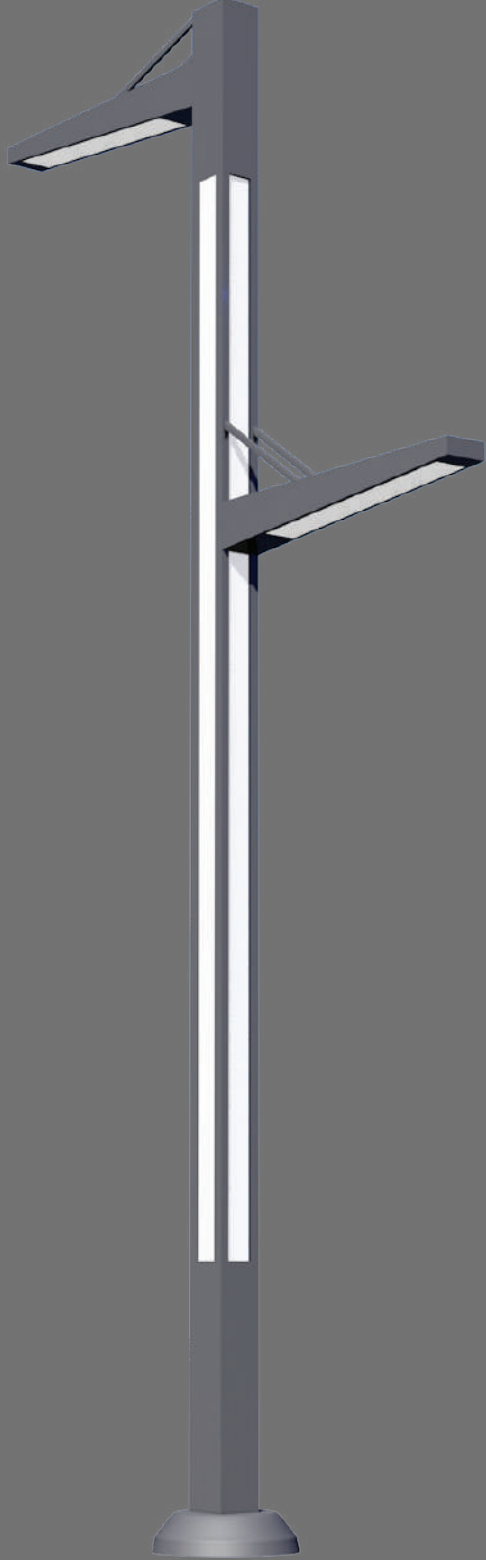

## ANATOLIA POWERFUL

Profil Detayı Profile Detail	Lens Lens	Led Modül Led Module	Gövde Body	Kaide Tipi Base Type
			Çelik / Steel 40*100 Kalınlık / Thickness 1,5 mm	Alüminyum & Çelik Aluminium & Steel

Şerit Led Detay  
Led Strip Detail

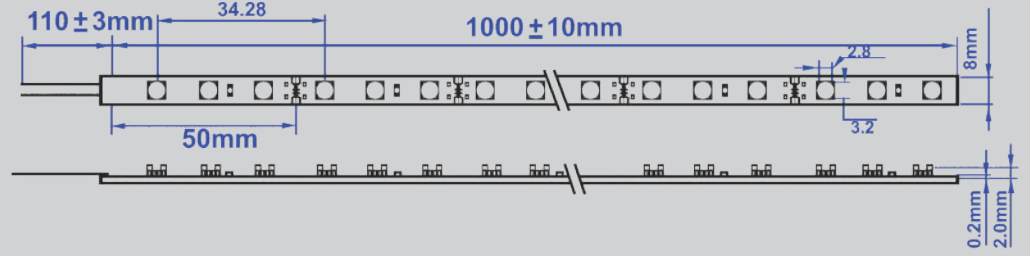

Ürün Belgeleri Product Documents			
Ürün Sertifikaları Product Certificates	TS EN 605 98-1-2 TS EN 605 98-1 TS 8700 EN 605 98-2-3	ISO 9001:2008 ISO 14001:2004 ISO 18002	OHSAS 18001:2007

**AnatoliaLED®**  
LED LIGHTING TECHNOLOGY



HAKÖZ®  
Működés és Megbízhatóság

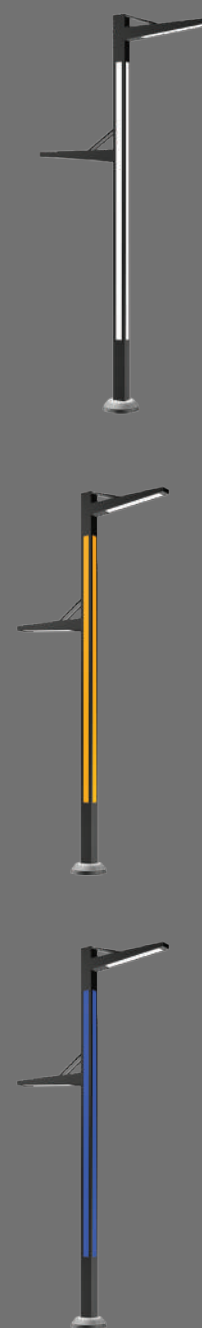

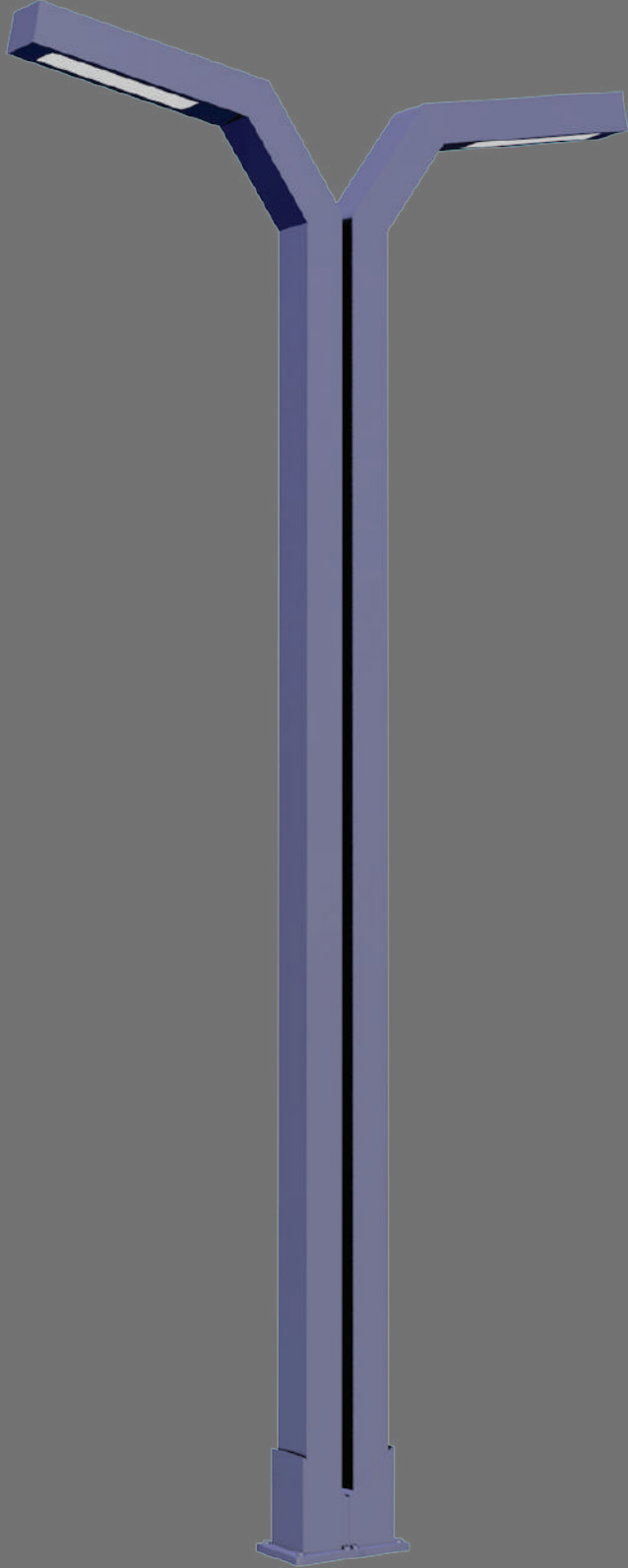

## ANATOLIA ANTOHER

Profil Detayı Profile Detail	Lens Lens	Led Modül Led Module	Gövde Body	Kaide Tipi Base Type
			Çelik / Steel 40*100 Kalınlık / Thickness 1,5 mm	Alüminyum & Çelik Aluminium & Steel

Şerit Led Detay  
Led Strip Detail

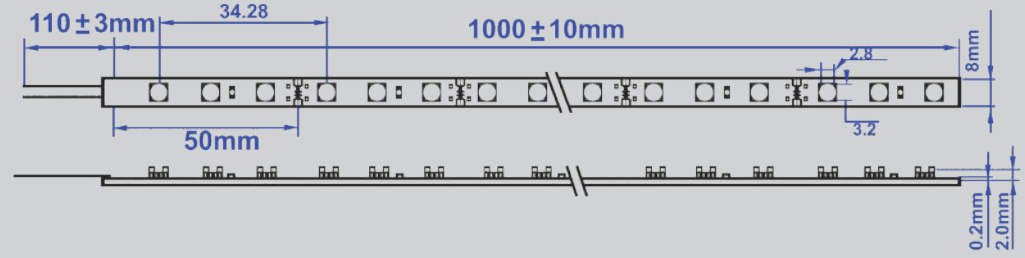

Ürün Belgeleri Product Documents			
Ürün Sertifikaları Product Certificates	TS EN 605 98-1-2 TS EN 605 98-1 TS 8700 EN 605 98-2-3	ISO 9001:2008 ISO 14001:2004 ISO 18002	OHSAS 18001:2007

**AnatoliaLED®**  
LED LIGHTING TECHNOLOGY



Güneş  
Paneli  
Aydınlatma  
Grubu

Solar  
Panel  
Lighting  
Group

Anatolia LED®





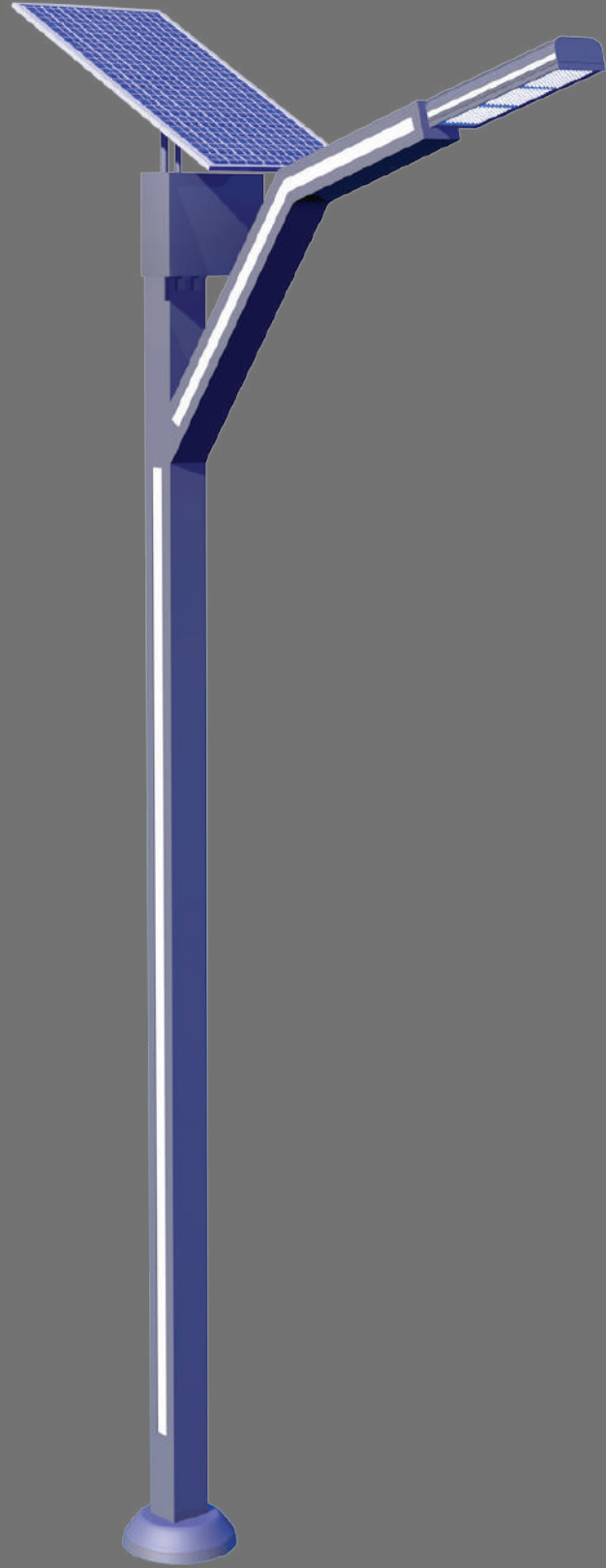

## ANATOLIA SUN

Profil Detayı Profile Detail	Alüminyum Armatür Aluminium Armature	Armatür Kapak Armature Cover	Gövde Body	Kaide Tipi Base Type
			Alüminyum & Çelik Aluminium & Steel	Alüminyum & Çelik Aluminium & Steel
Şerit Led Detayı Led Strip Detail				
Ürün Belgeleri Product Documents				
Ürün Sertifikaları Product Certificates	TS EN 605 98-1-2 TS EN 605 98-1 TS 8700 EN 605 98-2-3	ISO 9001:2008 ISO 14001:2004 ISO 18002	OHSAS 18001:2007	

**Anatolia LED**  
LED LIGHTING TECHNOLOGY



HAKOZ®  
működésük a megújulóknak

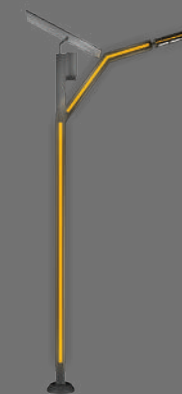
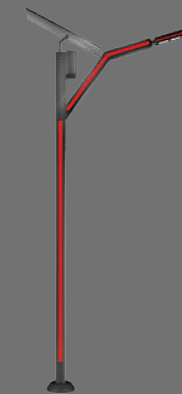



## ANATOLIA SUNSIHNE

Profil Detayı Profile Detail	Alüminyum Armatür Aluminum Armature	Armatür Kapak Armature Cover	Gövde Body	Kaide Tipi Base Type
			Alüminyum & Çelik Aluminium & Steel	Alüminyum & Çelik Aluminium & Steel

Şerit Led Detayı  
Led Strip Detail

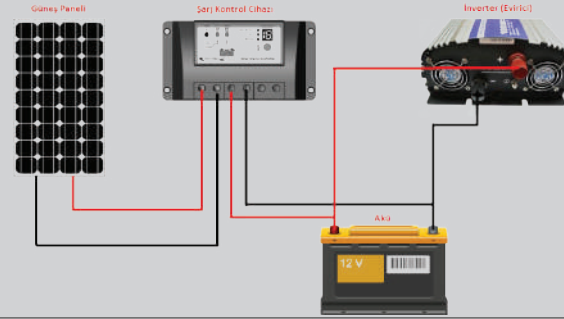
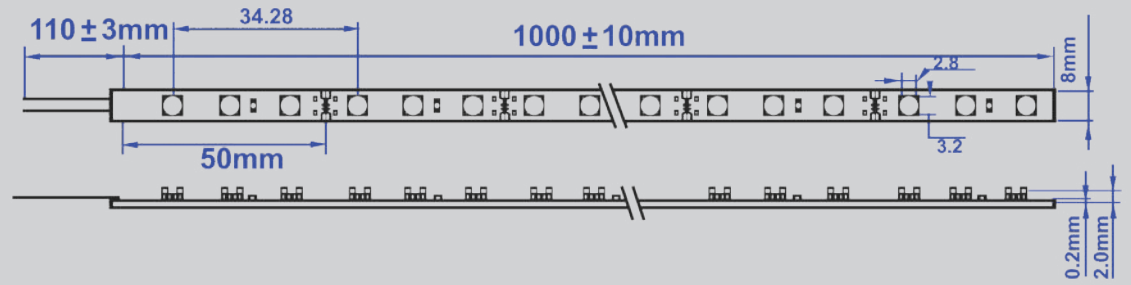

Ürün Belgeleri Product Documents			
Ürün Sertifikaları Product Certificates	TS EN 605 98-1-2 TS EN 605 98-1 TS 8700 EN 605 98-2-3	ISO 9001:2008 ISO 14001:2004 ISO 18002	OHSAS 18001:2007

**AnatoliaLED®**  
LED LIGHTING TECHNOLOGY





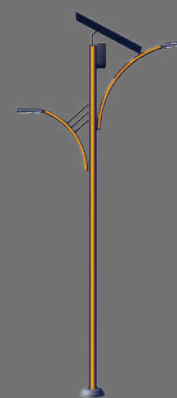
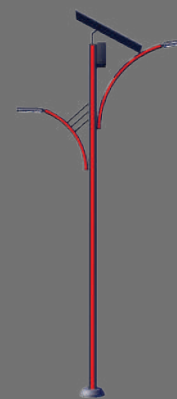

HAKÖZ<sup>®</sup>



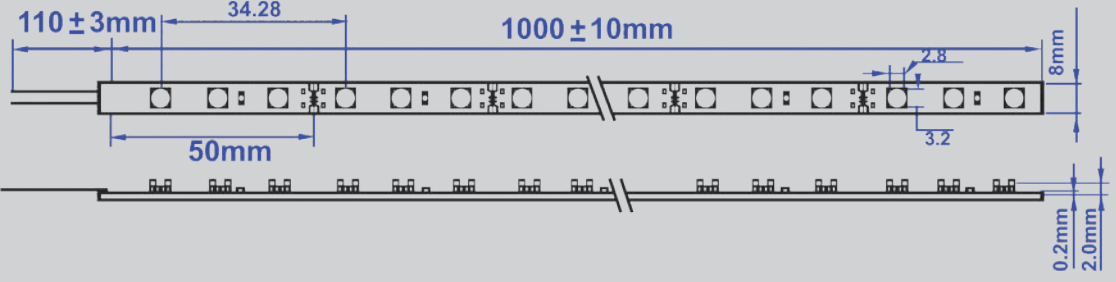

## 30,60,90W SOLAR LED ARMATÜR

Armatür Çeşitleri / Armature Types	Gövde Body	Kaide Tipi Base Type	
	Alüminyum & Çelik Aluminium & Steel	Alüminyum & Çelik Aluminium & Steel	
Şerit Led Detay Led Strip Detail			
			
Ürün Belgeleri Product Documents			
Ürün Sertifikaları Product Certificates	TS EN 605 98-1-2 TS EN 605 98-1 TS 8700 EN 605 98-2-3	ISO 9001:2008 ISO 14001:2004 ISO 18002	OHSAS 18001:2007

**AnatoliaLED**  
LED LIGHTING TECHNOLOGY



HAKOZ®  
Mühendislik & Enerji Hizmetleri

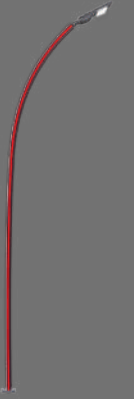

Dekoratif  
Ürün  
Grubu

Decorative  
Product  
Group

Anatolia LED®

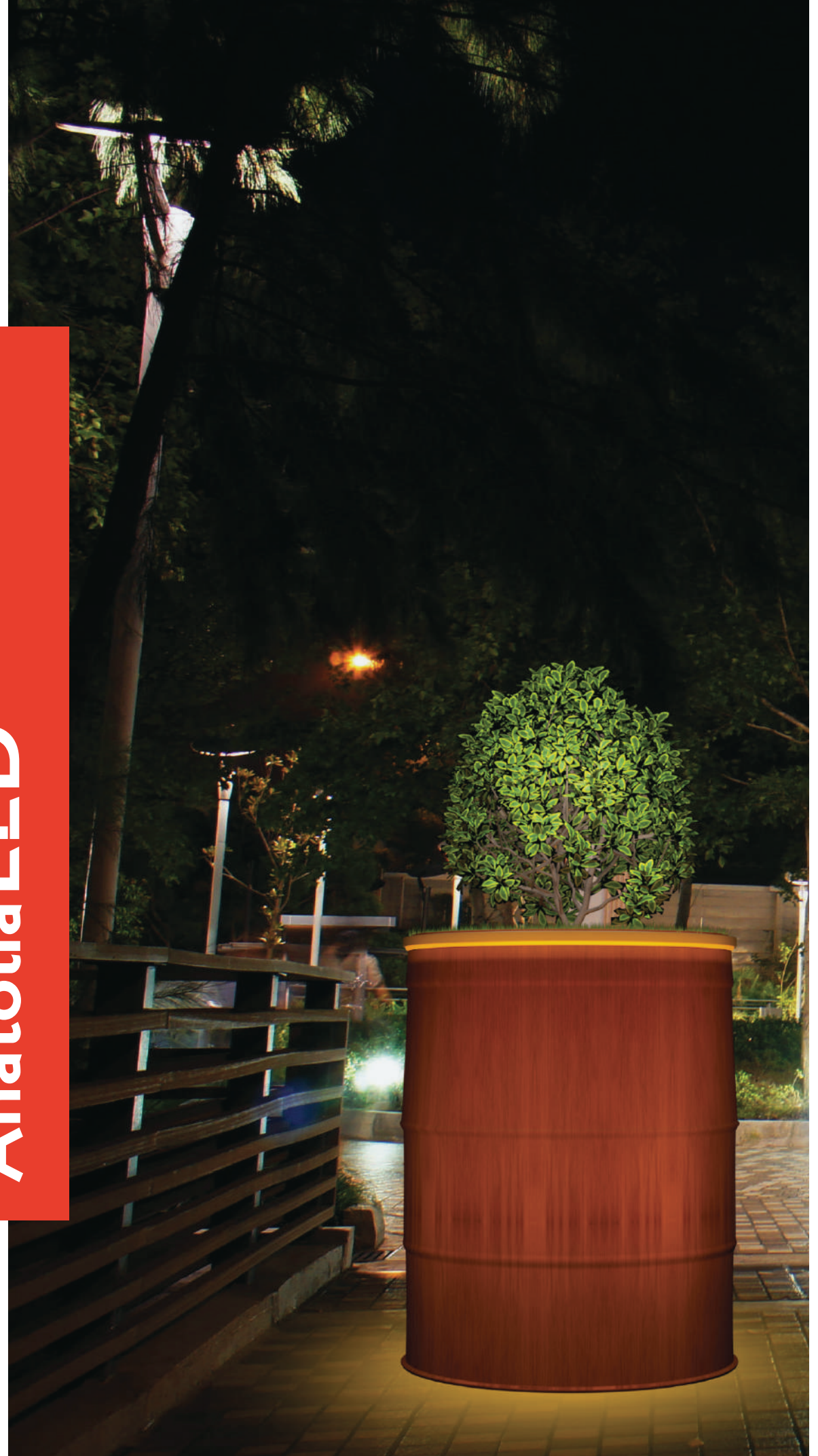



## ANATOLIA SIDE

Şerit Led Detay  
Led Strip Detail

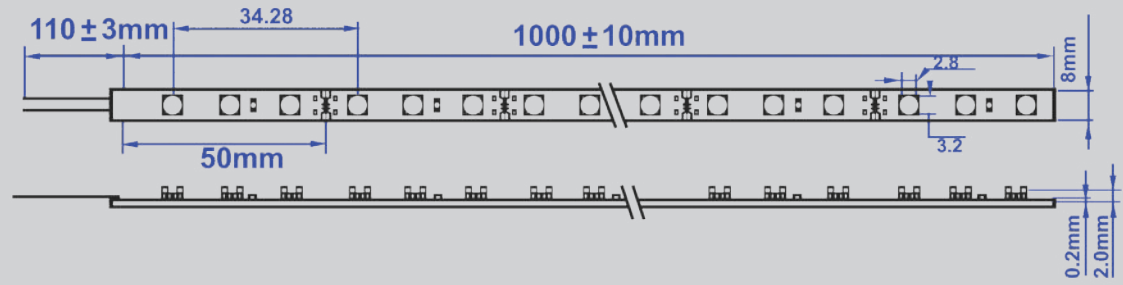

Ürün Belgeleri  
Product Documents



Ürün Sertifikaları  
Product Certificates

TS EN 605 98-1-2  
TS EN 605 98-1  
TS 8700 EN 605 98-2-3

ISO 9001:2008  
ISO 14001:2004  
ISO 18002

OHSAS 18001:2007

**Anatolia LED**  
LED LIGHTING TECHNOLOGY

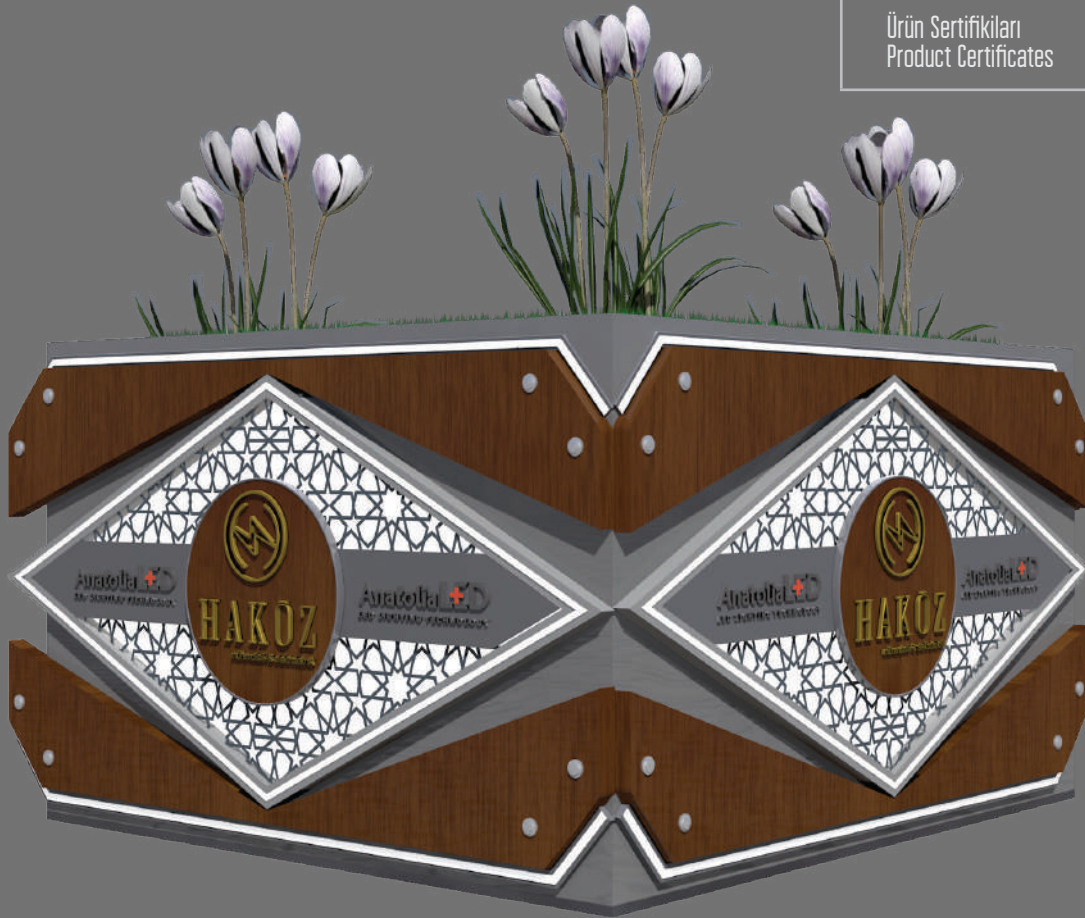



## ANATOLIA ELIPS

Şerit Led Detay  
Led Strip Detail

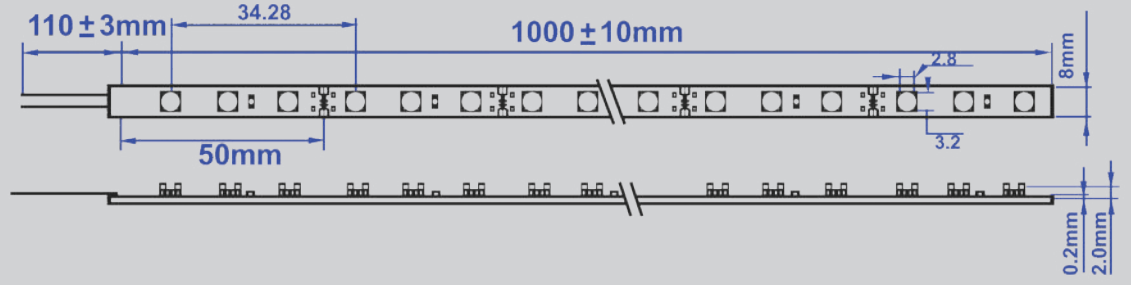

Ürün Belgeleri  
Product Documents



Ürün Sertifikaları  
Product Certificates

TS EN 605 98-1-2  
TS EN 605 98-1  
TS 8700 EN 605 98-2-3

ISO 9001:2008  
ISO 14001:2004  
ISO 18002

OHSAS 18001:2007

**AnatoliaLED**  
LED LIGHTING TECHNOLOGY





## ANATOLIA TUB

Şerit Led Detay  
Led Strip Detail

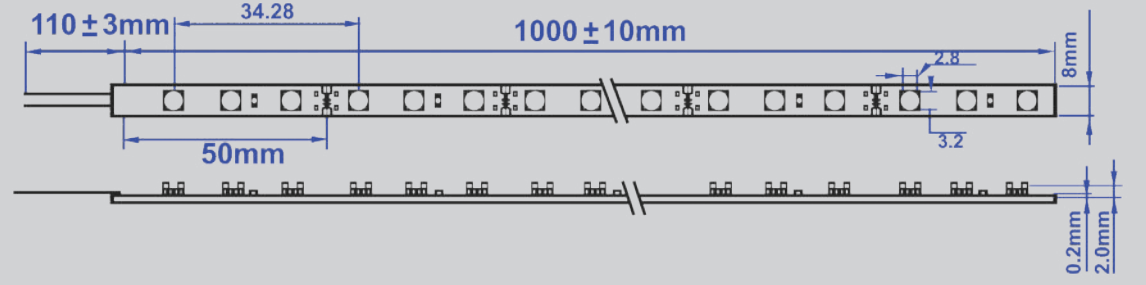

Ürün Belgeleri  
Product Documents



Ürün Sertifikaları  
Product Certificates

TS EN 605 98-1-2  
TS EN 605 98-1  
TS 8700 EN 605 98-2-3

ISO 9001:2008  
ISO 14001:2004  
ISO 18002





OHSAS 18001:2007

**Anatolia LED**  
LED LIGHTING TECHNOLOGY



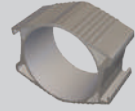
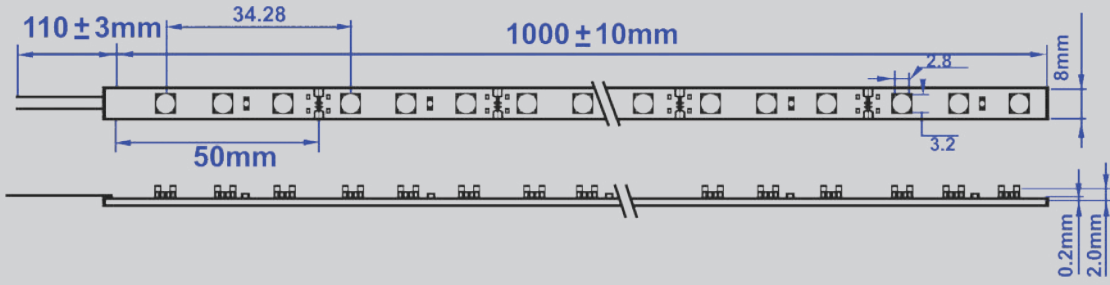

## REKLAM PANO

Profil Detayı Profile Detail	Gövde Body	Kaide Tipi Base Type	
	Alüminyum & Çelik Aluminium & Steel	Alüminyum & Çelik Aluminium & Steel	
Şerit Led Detayı Led Strip Detail			
			
Ürün Belgeleri Product Documents			
Ürün Sertifikaları Product Certificates	TS EN 605 98-1-2 TS EN 605 98-1 TS 8700 EN 605 98-2-3	ISO 9001:2008 ISO 14001:2004 ISO 10002	OHSAS 18001:2007



**AnatoliaLED<sup>®</sup>**  
LED LIGHTING TECHNOLOGY

Meydan  
Aydınlatma  
Grubu

Field  
Lighting  
Group

Anatolia LED®

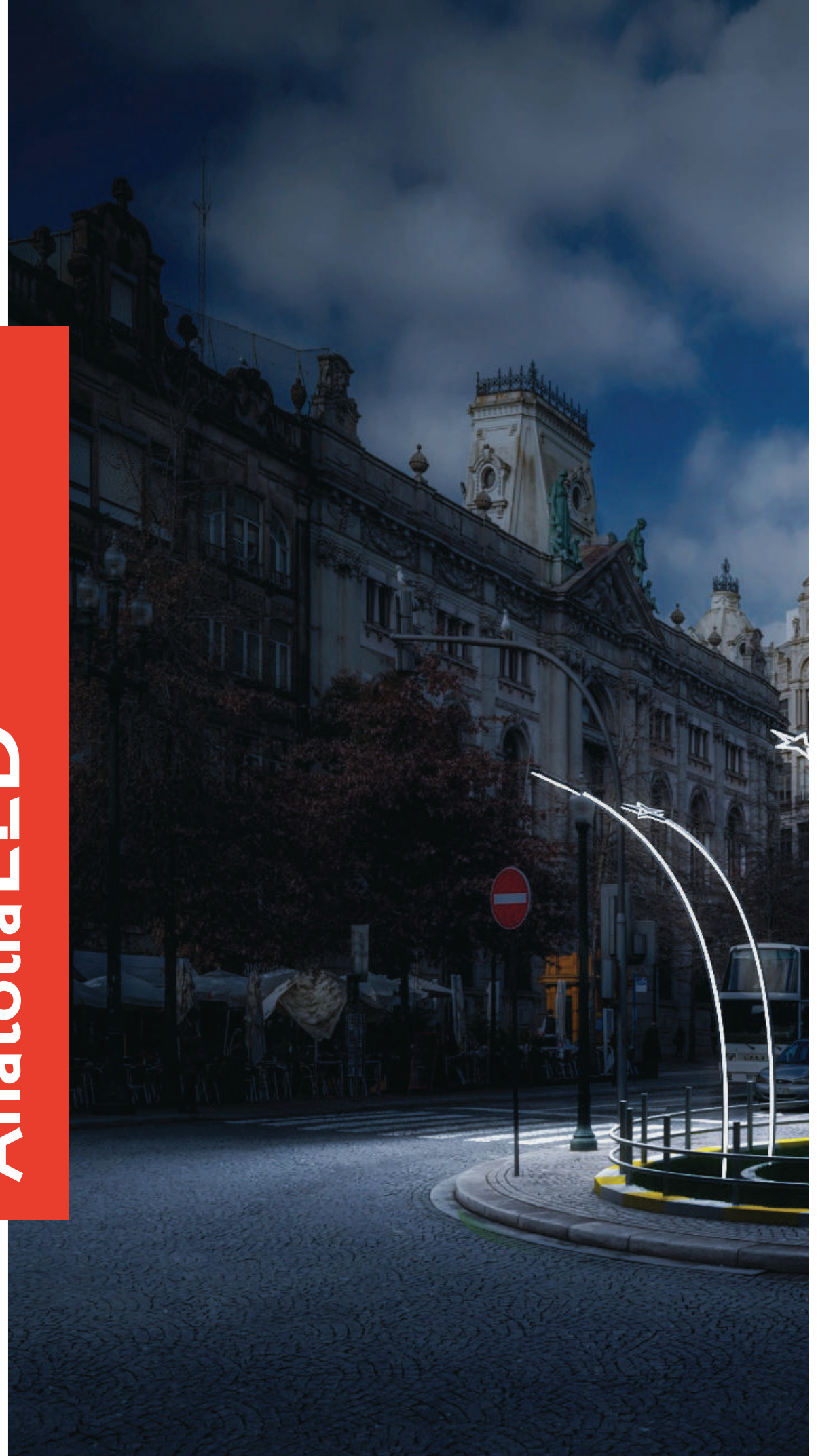



## ANATOLIA ARMOR

Profil Detayı Profile Detail	Alüminyum Armatür Aluminum Armature	Armatür Kapak Armature Cover	Gövde Body	Kaide Tipi Base Type
			Alüminyum & Çelik Aluminium & Steel	Alüminyum & Çelik Aluminium & Steel

Şerit Led Detay  
Led Strip Detail

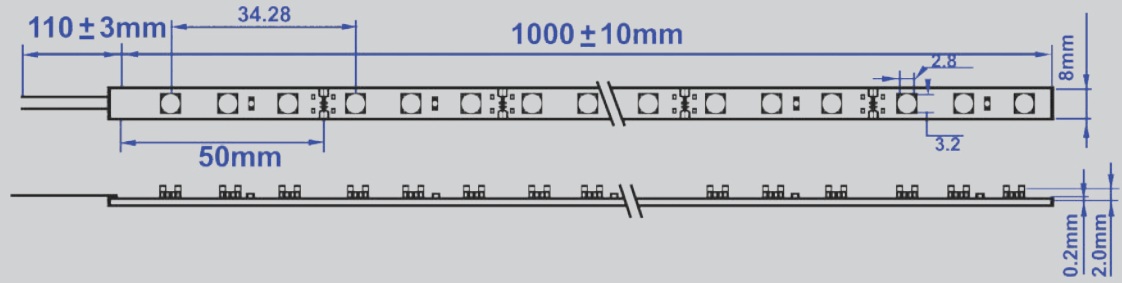

Ürün Belgeleri Product Documents			
Ürün Sertifikaları Product Certificates	TS EN 605 98-1-2 TS EN 605 98-1 TS 8700 EN 605 98-2-3	ISO 9001:2008 ISO 14001:2004 ISO 18002	OHSAS 18001:2007

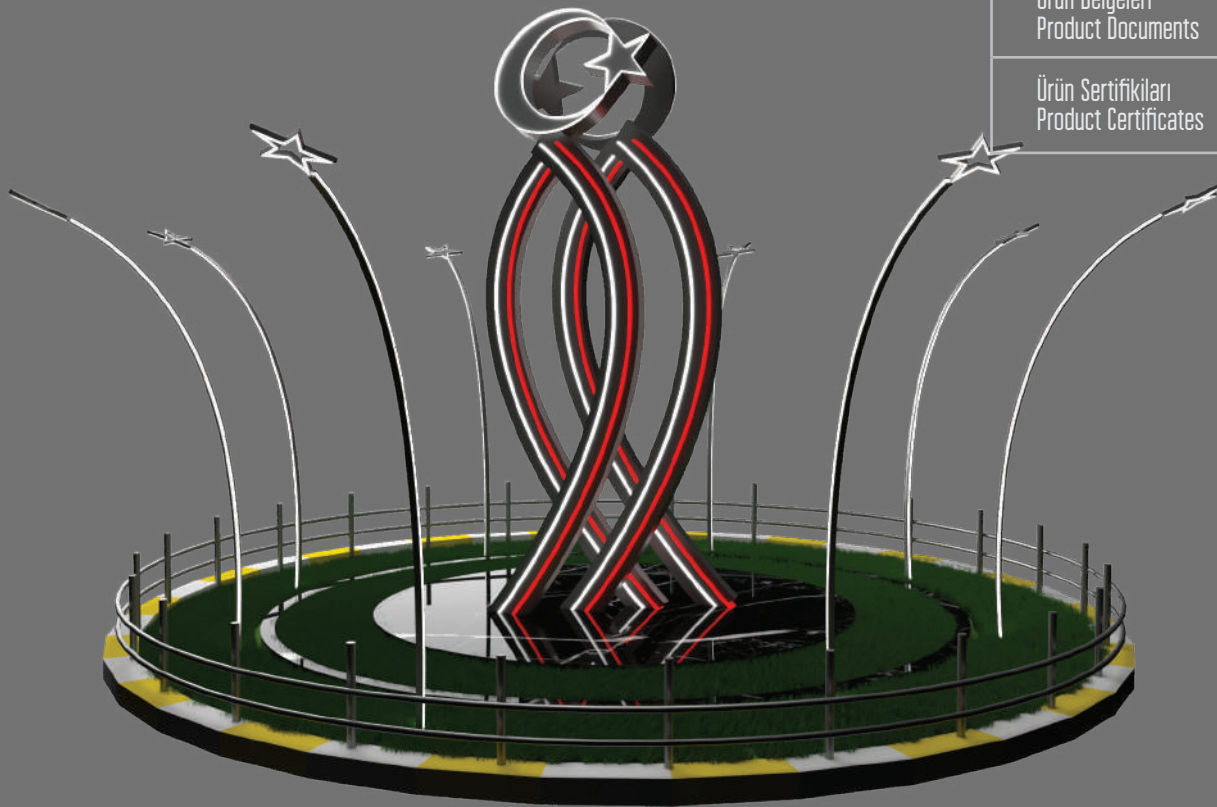

**Anatolia LED**  
LED LIGHTING TECHNOLOGY





## ANATOLIA BUKET

Profil Detayı Profile Detail	Alüminyum Armatür Aluminum Armature	Armatür Kapak Armature Cover	Gövde Body	Kaide Tipi Base Type
			Alüminyum & Çelik Aluminium & Steel	Alüminyum & Çelik Aluminium & Steel

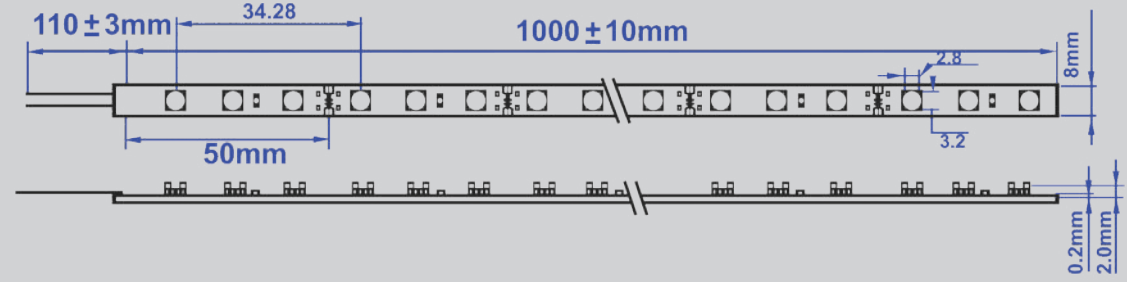
Şerit Led Detay  
Led Strip Detail



Ürün Belgeleri Product Documents			
Ürün Sertifikaları Product Certificates	TS EN 605 98-1-2 TS EN 605 98-1 TS 8700 EN 605 98-2-3	ISO 9001:2008 ISO 14001:2004 ISO 18002	OHSAS 18001:2007

**AnatoliaLED®**  
LED LIGHTING TECHNOLOGY

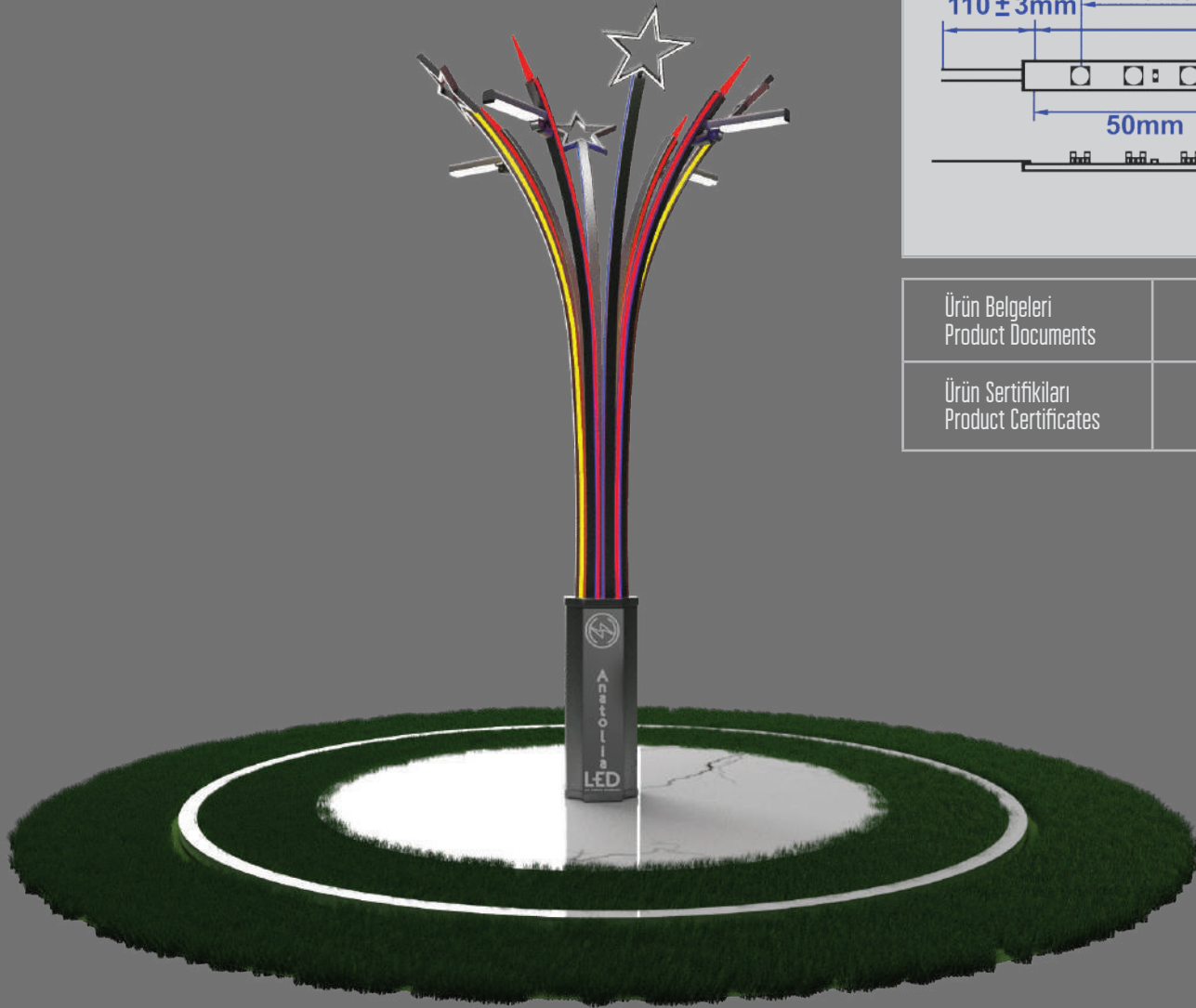



## ANATOLIA ÇİÇEK

Profil Detayı Profile Detail	Alüminyum Armatür Aluminum Armature	Armatür Kapak Armature Cover	Gövde Body	Kaide Tipi Base Type
			Alüminyum & Çelik Aluminium & Steel	Alüminyum & Çelik Aluminium & Steel

### Şerit Led Detayı Led Strip Detail

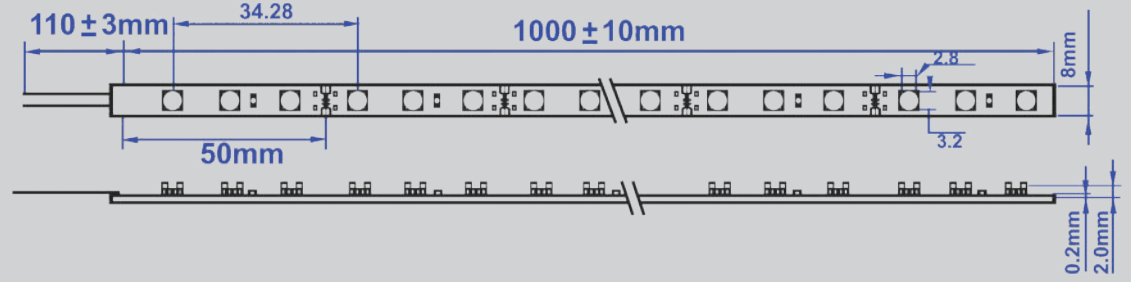

Ürün Belgeleri Product Documents			
Ürün Sertifikaları Product Certificates	TS EN 605 98-1-2 TS EN 605 98-1 TS 8700 EN 605 98-2-3	ISO 9001:2008 ISO 14001:2004 ISO 18002	OHSAS 18001:2007

**Anatolia LED**  
LED LIGHTING TECHNOLOGY

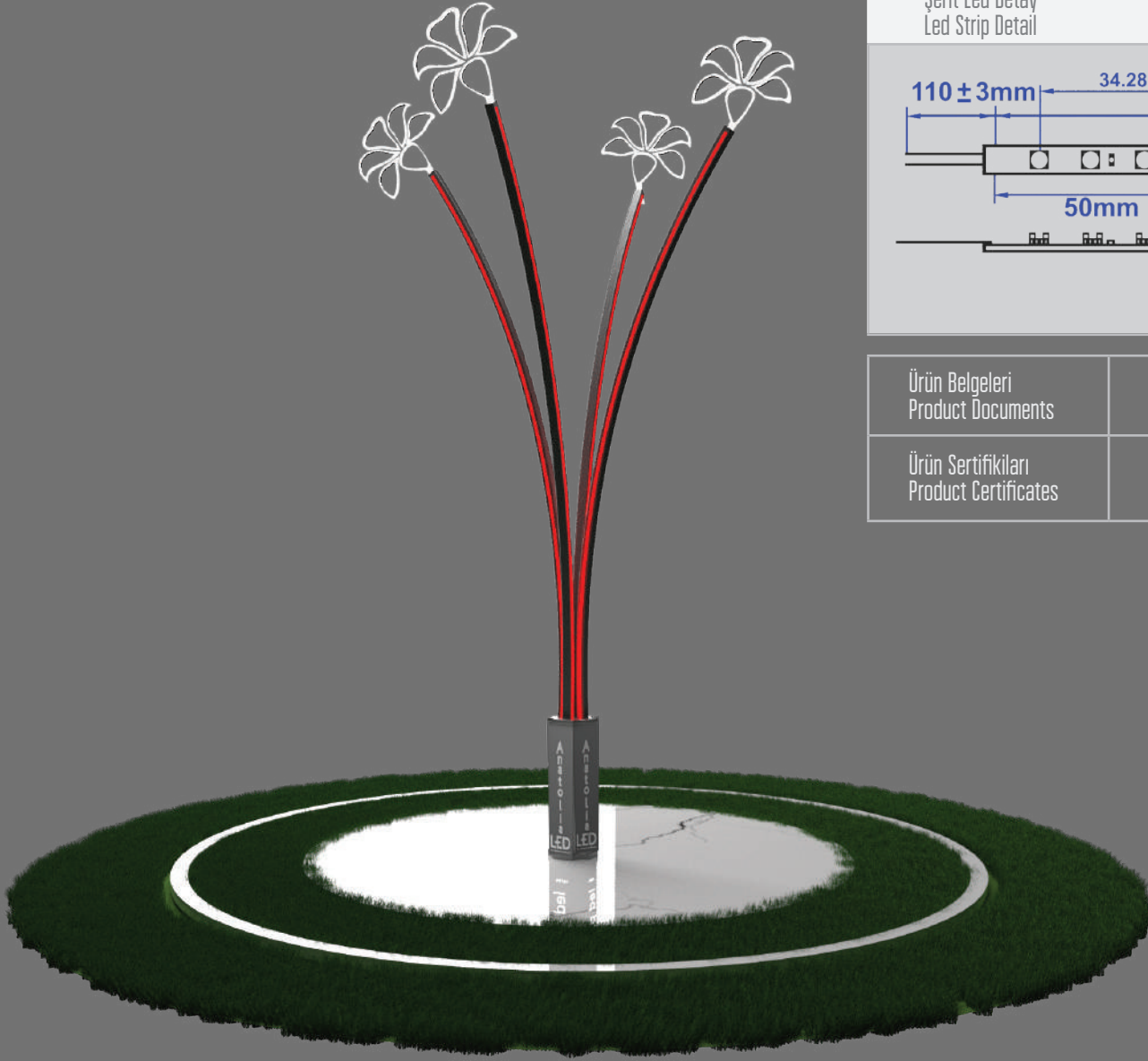





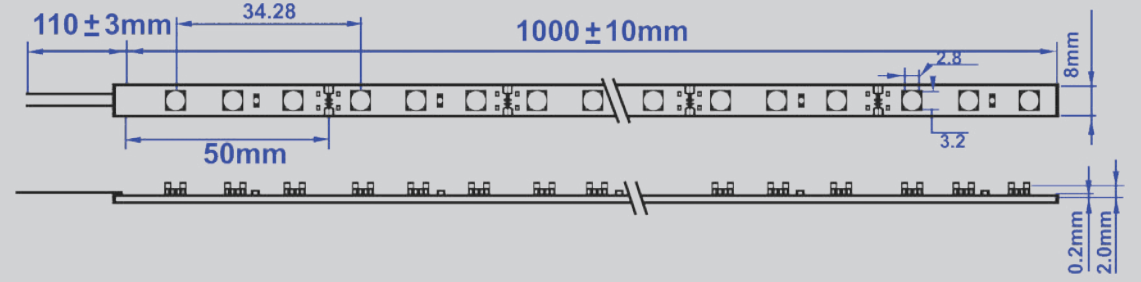

## ANATOLIA FLOWER

Profil Detayı Profile Detail	Alüminyum Armatür Aluminum Armature	Armatür Kapak Armature Cover	Gövde Body	Kaide Tipi Base Type
			Alüminyum & Çelik Aluminium & Steel	Alüminyum & Çelik Aluminium & Steel

Şerit Led Detayı  
Led Strip Detail



Ürün Belgeleri Product Documents			
Ürün Sertifikaları Product Certificates	TS EN 605 98-1-2 TS EN 605 98-1 TS 8700 EN 605 98-2-3	ISO 9001:2008 ISO 14001:2004 ISO 18002	OHSAS 18001:2007

**Anatolia LED**  
LED LIGHTING TECHNOLOGY

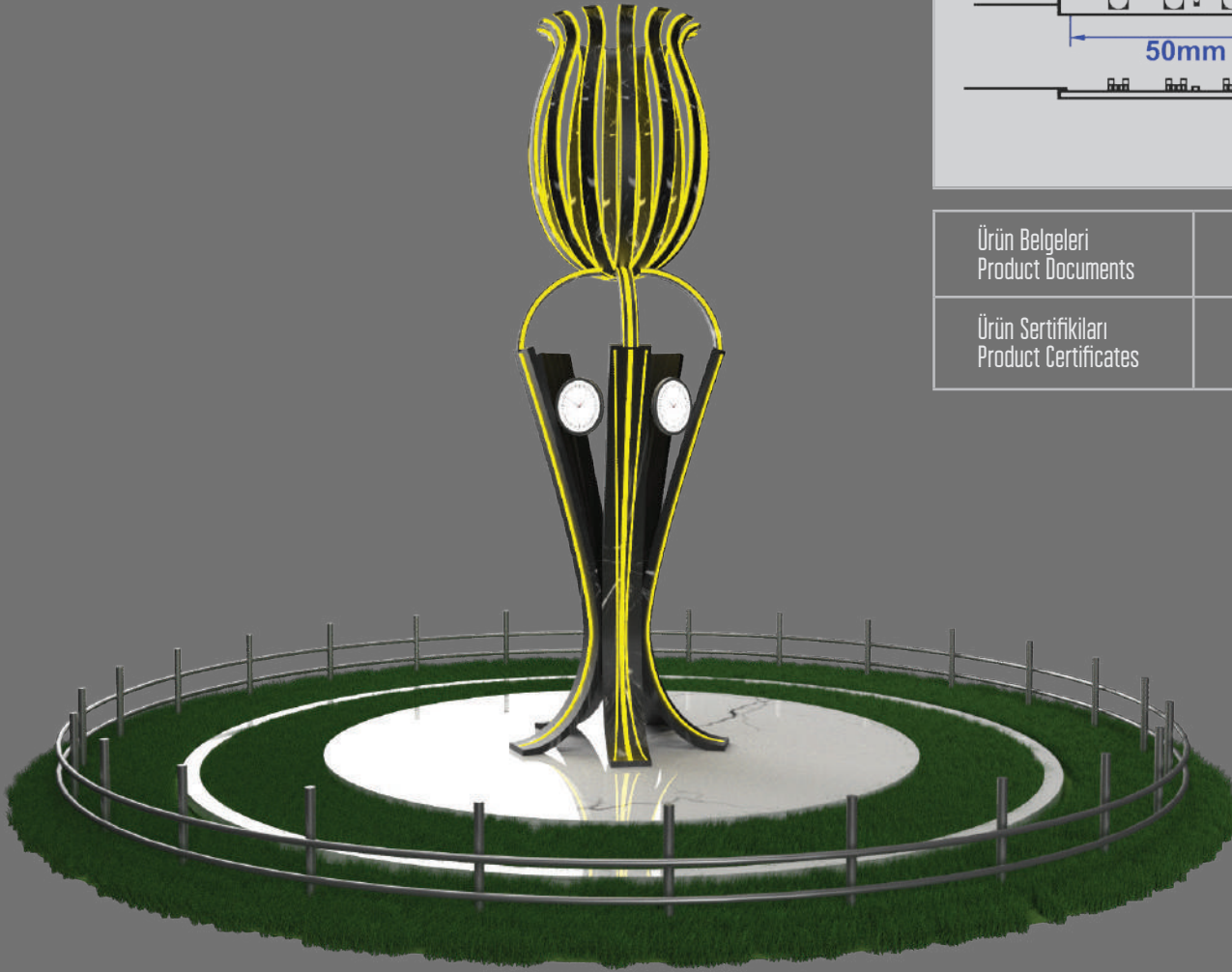



## ANATOLIA LALE

Profil Detayı Profile Detail	Alüminyum Armatür Aluminum Armature	Armatür Kapak Armature Cover	Gövde Body	Kaide Tipi Base Type
			Alüminyum & Çelik Aluminium & Steel	Alüminyum & Çelik Aluminium & Steel

Şerit Led Detayı  
Led Strip Detail

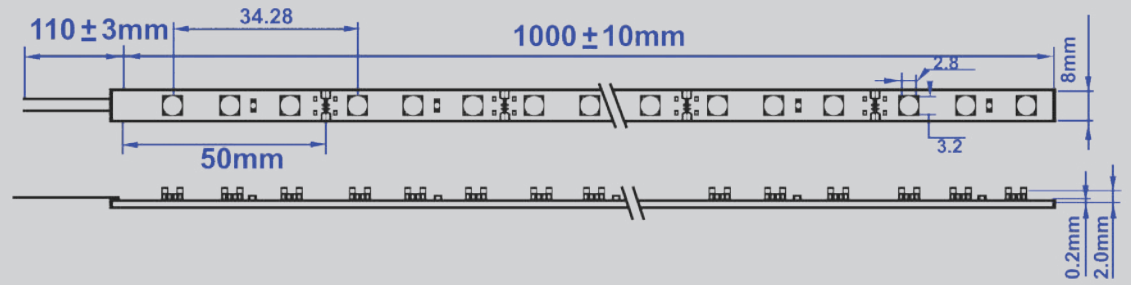

Ürün Belgeleri Product Documents			
Ürün Sertifikaları Product Certificates	TS EN 605 98-1-2 TS EN 605 98-1 TS 8700 EN 605 98-2-3	ISO 9001:2008 ISO 14001:2004 ISO 18002	OHSAS 18001:2007

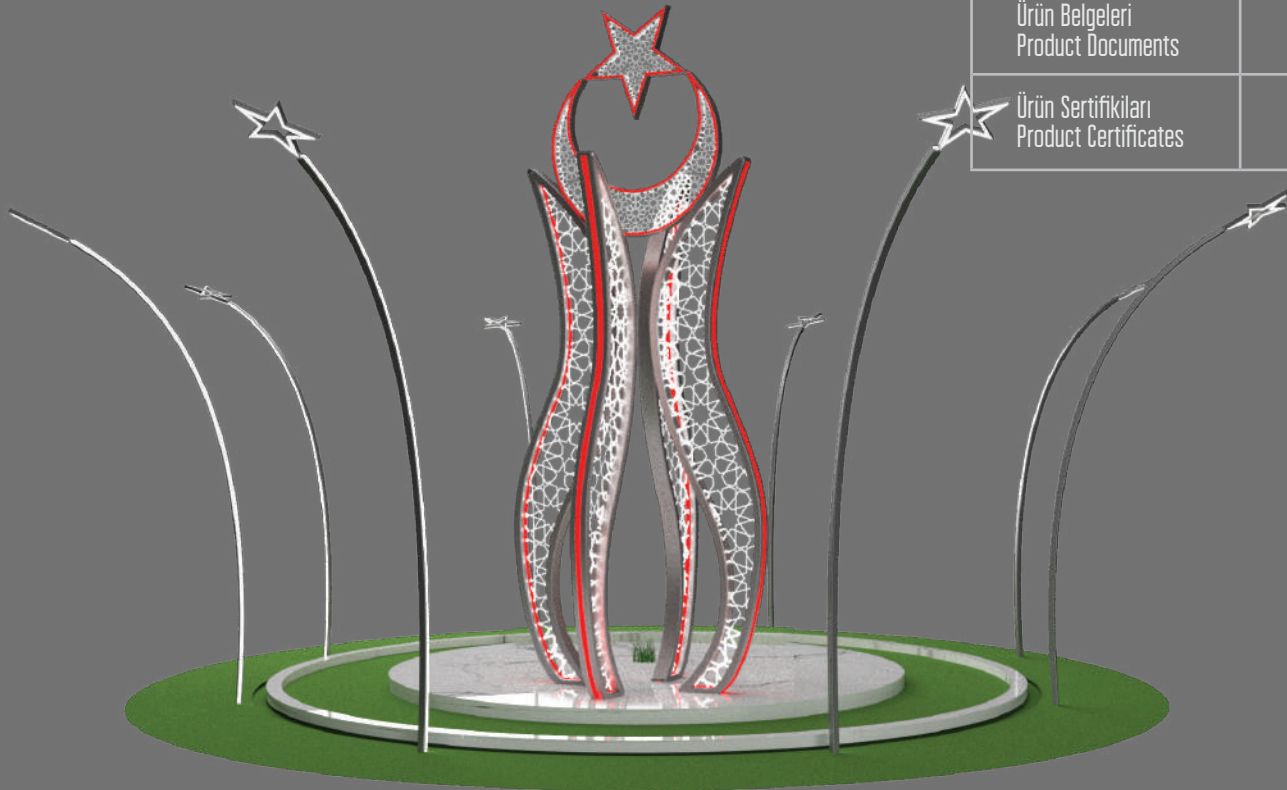

**Anatolia LED**  
LED LIGHTING TECHNOLOGY





## POWER OF STAR

Profil Detayı Profile Detail	Alüminyum Armatür Aluminum Armature	Armatür Kapak Armature Cover	Gövde Body	Kaide Tipi Base Type
			Alüminyum & Çelik Aluminium & Steel	Alüminyum & Çelik Aluminium & Steel

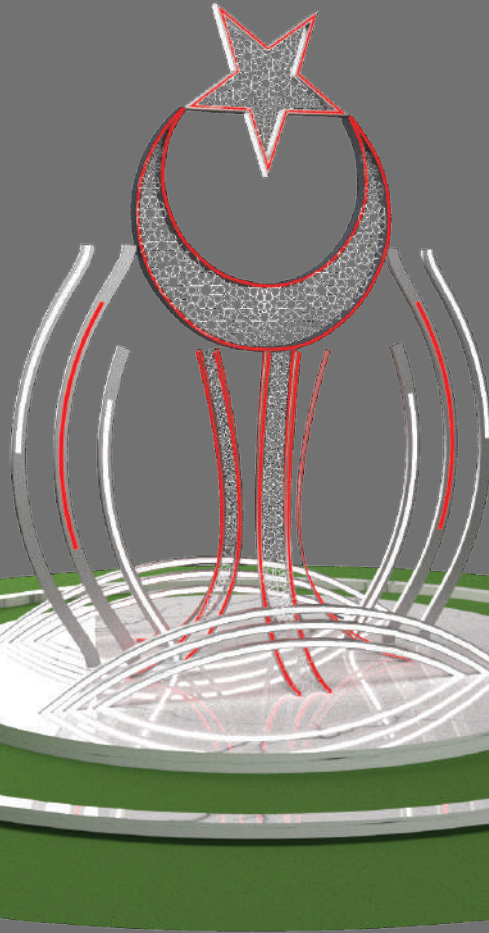
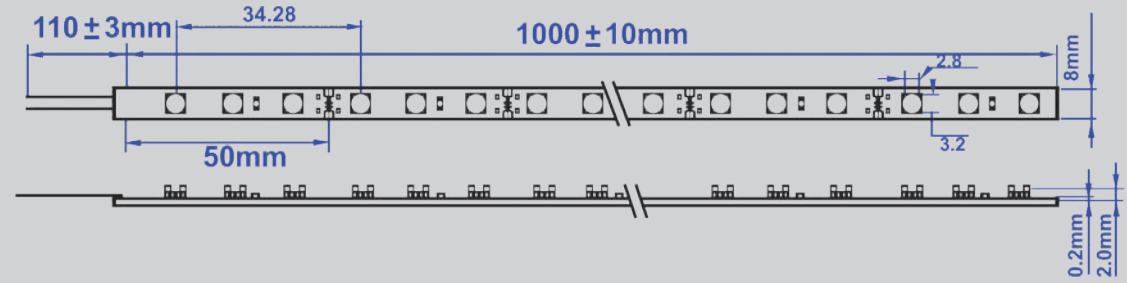
Şerit Led Detayı  
Led Strip Detail



Ürün Belgeleri Product Documents			
Ürün Sertifikaları Product Certificates	TS EN 605 98-1-2 TS EN 605 98-1 TS 8700 EN 605 98-2-3	ISO 9001:2008 ISO 14001:2004 ISO 18002	OHSAS 18001:2007

**AnatoliaLED®**  
LED LIGHTING TECHNOLOGY





# TUĞRA

Profil Detayı Profile Detail	Alüminyum Armatür Aluminum Armature	Armatür Kapak Armature Cover	Gövde Body	Kaide Tipi Base Type
			Alüminyum & Çelik Aluminium & Steel	Alüminyum & Çelik Aluminium & Steel

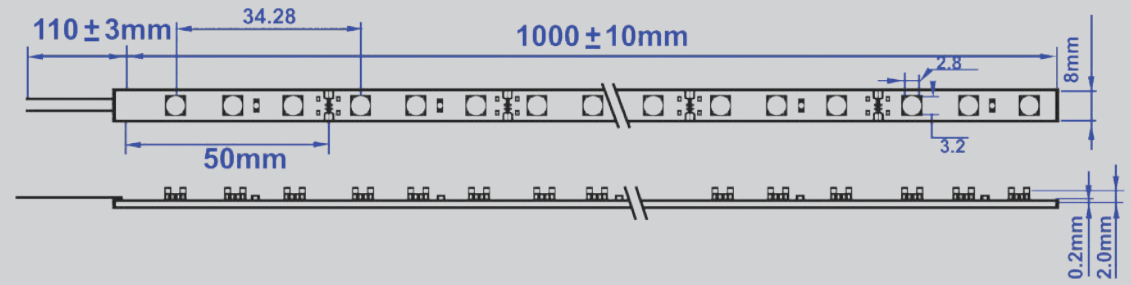
Şerit Led Detay  
Led Strip Detail



Ürün Belgeleri Product Documents			
Ürün Sertifikaları Product Certificates	TS EN 605 98-1-2 TS EN 605 98-1 TS 8700 EN 605 98-2-3	ISO 9001:2008 ISO 14001:2004 ISO 18002	OHSAS 18001:2007



**AnatoliaLED®**  
LED LIGHTING TECHNOLOGY



Durak ve  
Korkuluk  
Aydınlatma  
Grubu

Bus Stop  
Railing and  
Lighting  
Group

Anatolia LED®



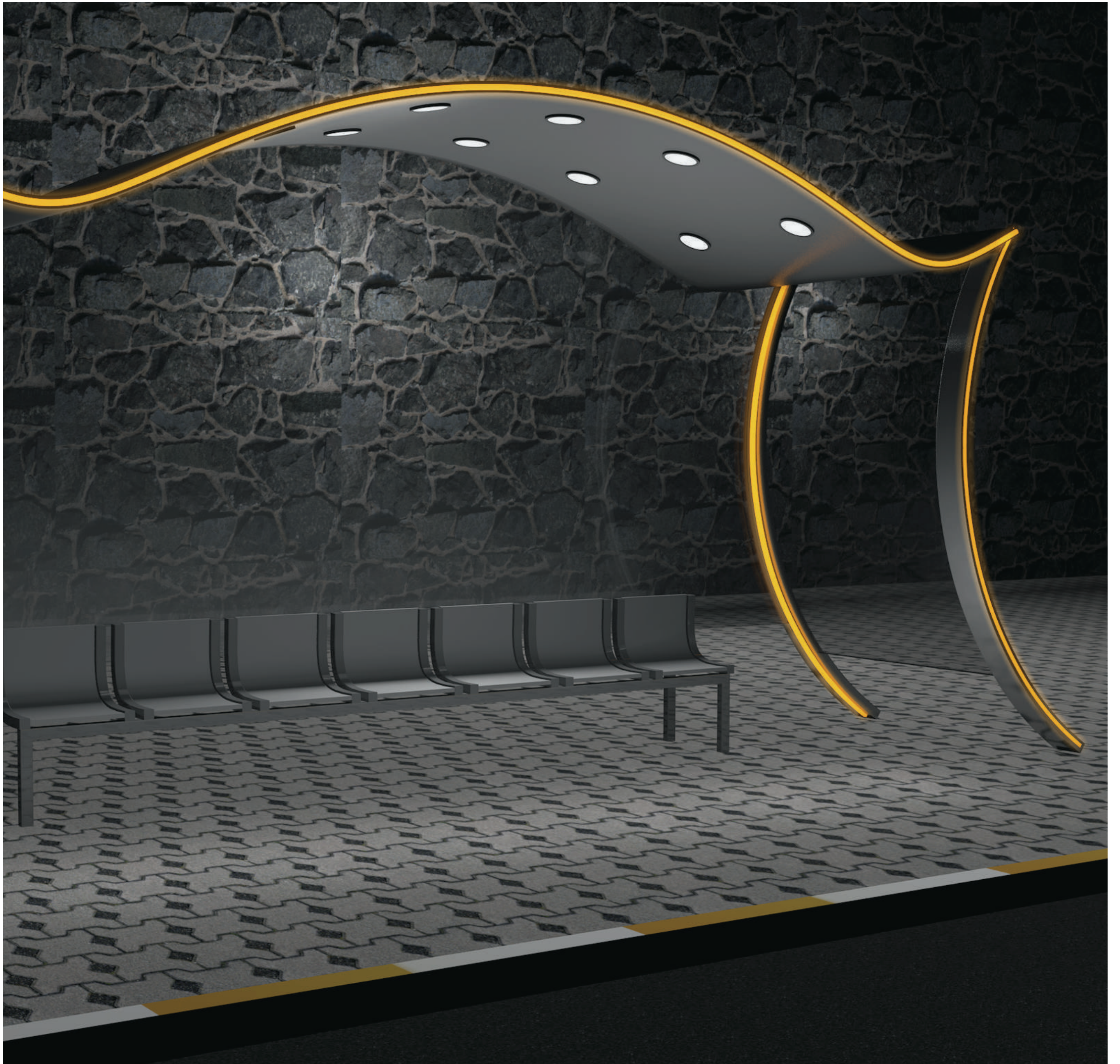



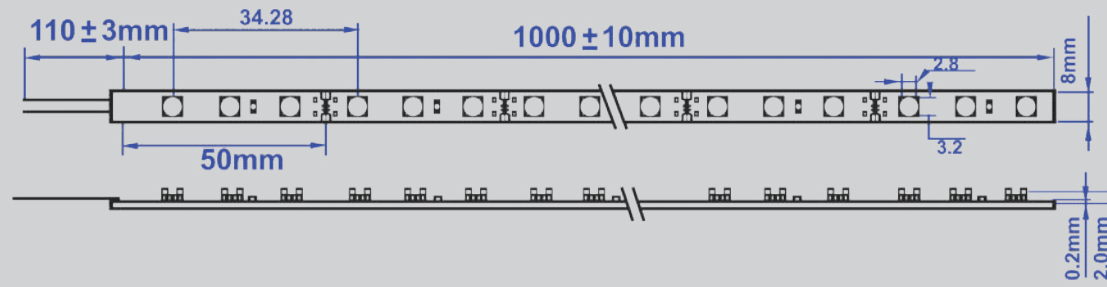

## ANATOLIA DURAK I

Profil Detayı Profile Detail	Gövde Body	Kaide Tipi Base Type
	Alüminyum & Çelik Aluminium & Steel	Alüminyum & Çelik Aluminium & Steel

Şerit Led Detay  
Led Strip Detail



Ürün Belgeleri Product Documents			
Ürün Sertifikaları Product Certificates	TS EN 605 98-1-2 TS EN 605 98-1 TS 8700 EN 605 98-2-3	ISO 9001:2008 ISO 14001:2004 ISO 10002	OHSAS 18001:2007

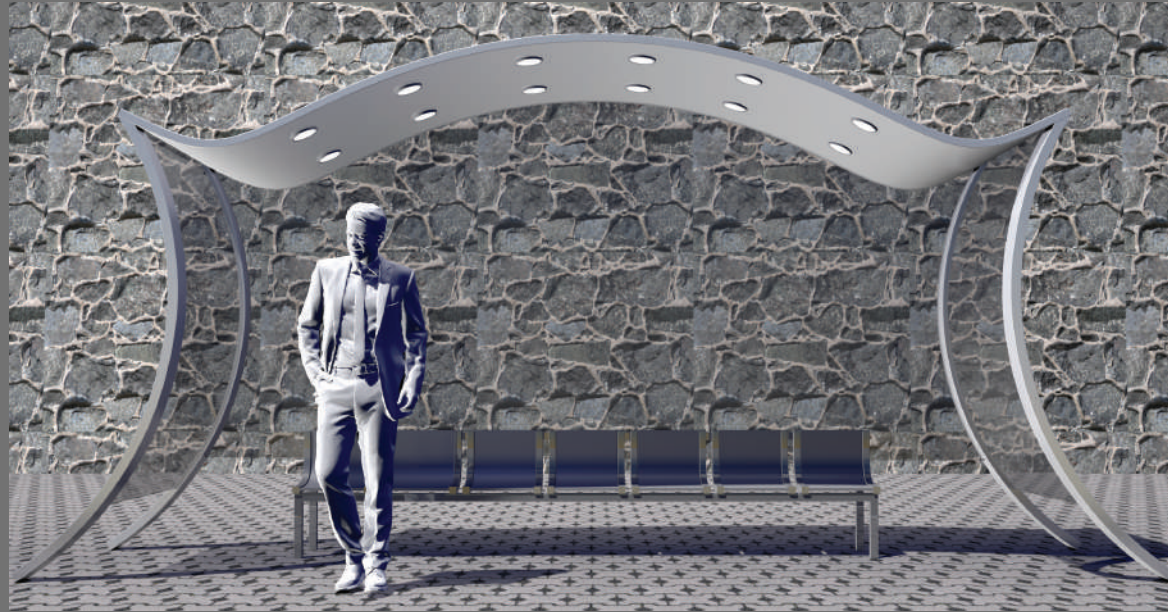

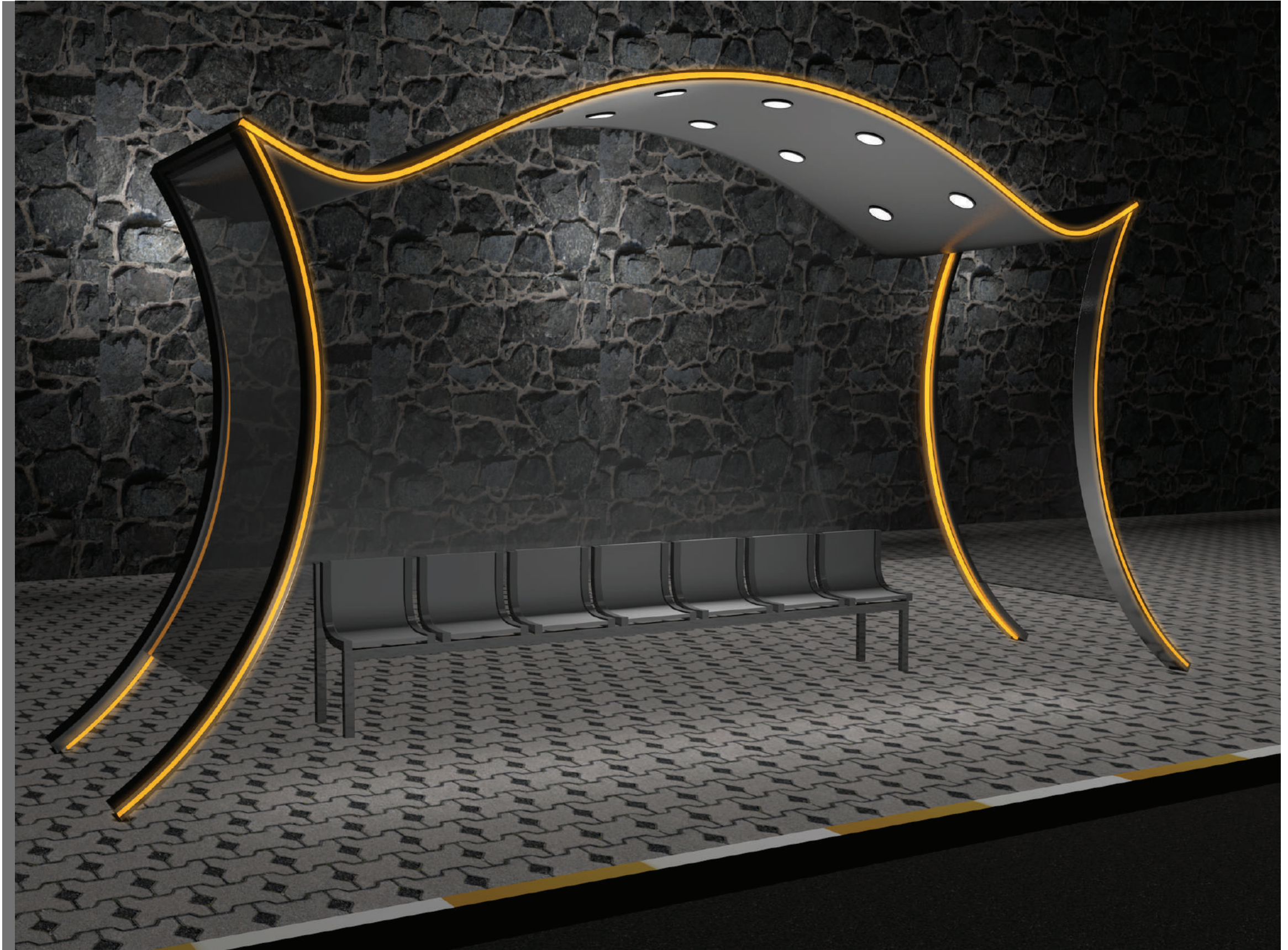



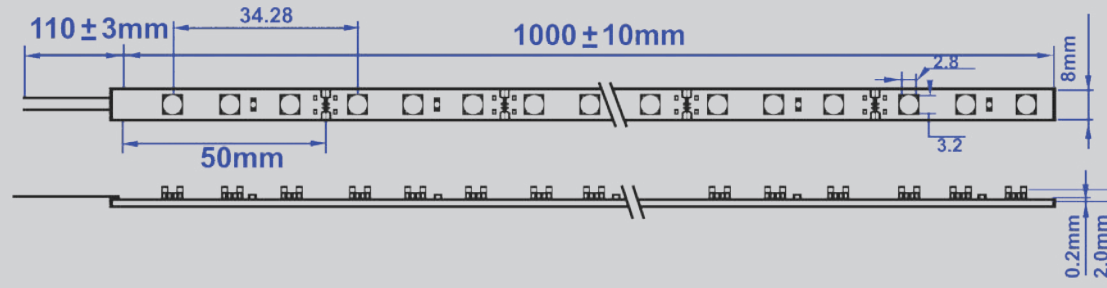

## ANATOLIA SHAPE

Profil Detayı Profile Detail	Gövde Body	Kaide Tipi Base Type
	Alüminyum & Çelik Aluminium & Steel	Alüminyum & Çelik Aluminium & Steel

Şerit Led Detay  
Led Strip Detail



Ürün Belgeleri Product Documents			
Ürün Sertifikaları Product Certificates	TS EN 605 98-1-2 TS EN 605 98-1 TS 8700 EN 605 98-2-3	ISO 9001:2008 ISO 14001:2004 ISO 18002	OHSAS 18001:2007

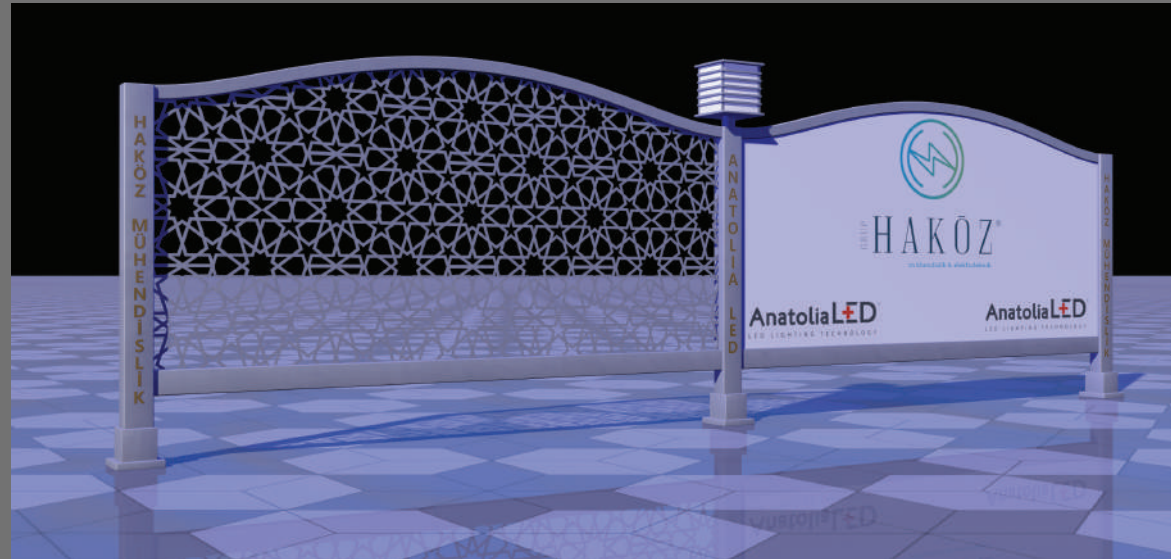



## ANATOLIA SHARP

Profil Detayı Profile Detail	Gövde Body	Kaide Tipi Base Type
	Alüminyum & Çelik Aluminium & Steel	Alüminyum & Çelik Aluminium & Steel

Şerit Led Detay  
Led Strip Detail

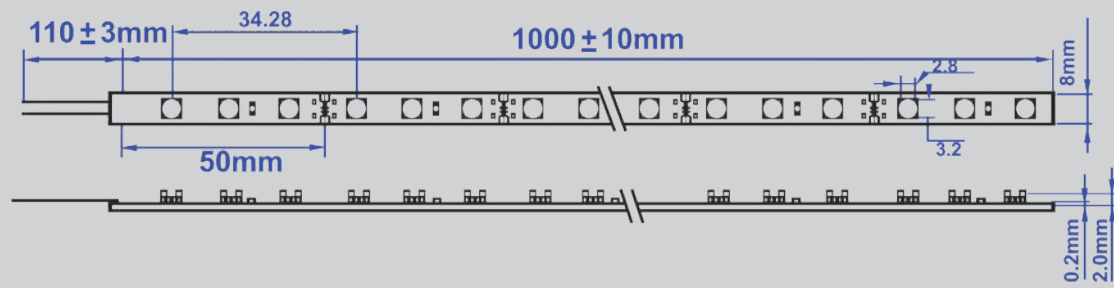

Ürün Belgeleri Product Documents			
Ürün Sertifikaları Product Certificates	TS EN 605 98-1-2 TS EN 605 98-1 TS 8700 EN 605 98-2-3	ISO 9001:2008 ISO 14001:2004 ISO 18002	OHSAS 18001:2007

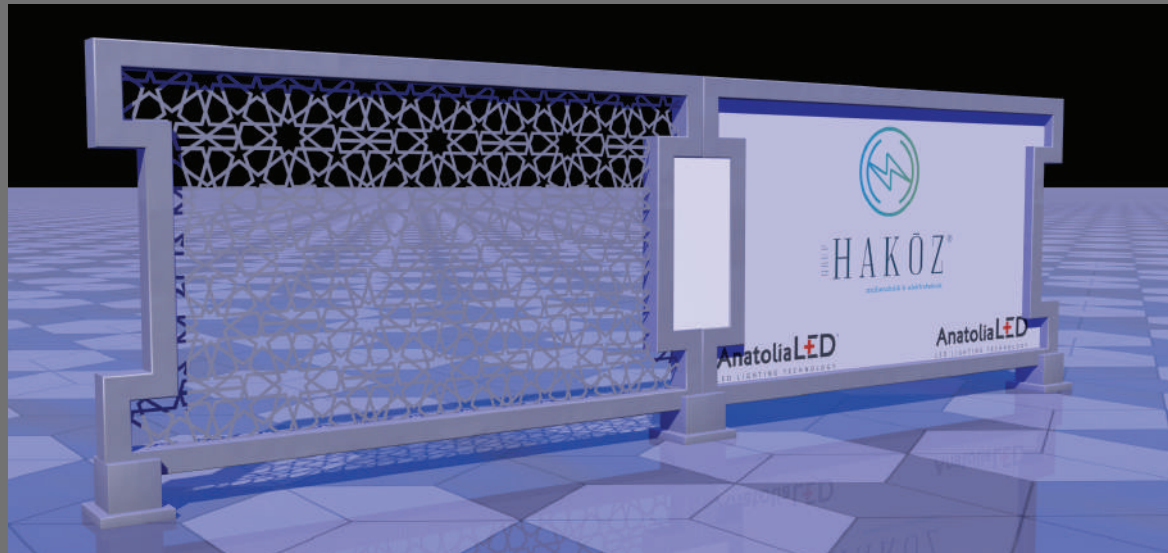





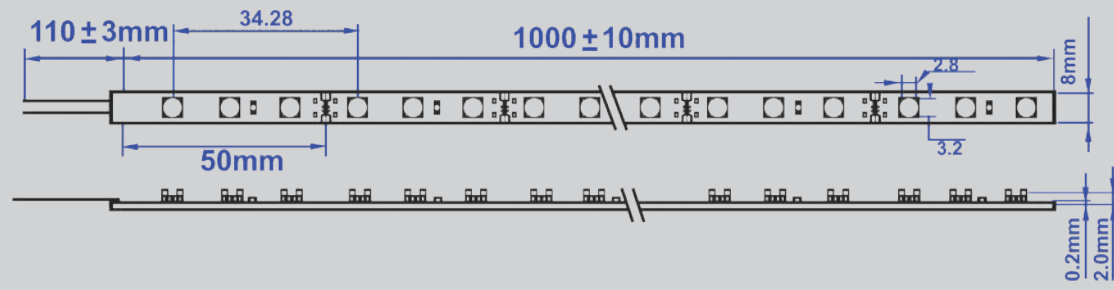

# ANATOLIA MASTER

Profil Detayı Profile Detail	Gövde Body	Kaide Tipi Base Type
	Alüminyum & Çelik Aluminium & Steel	Alüminyum & Çelik Aluminium & Steel

Şerit Led Detay  
Led Strip Detail



Ürün Belgeleri Product Documents			
Ürün Sertifikaları Product Certificates	TS EN 605 98-1-2 TS EN 605 98-1 TS 8700 EN 605 98-2-3	ISO 9001:2008 ISO 14001:2004 ISO 18002	OHSAS 18001:2007

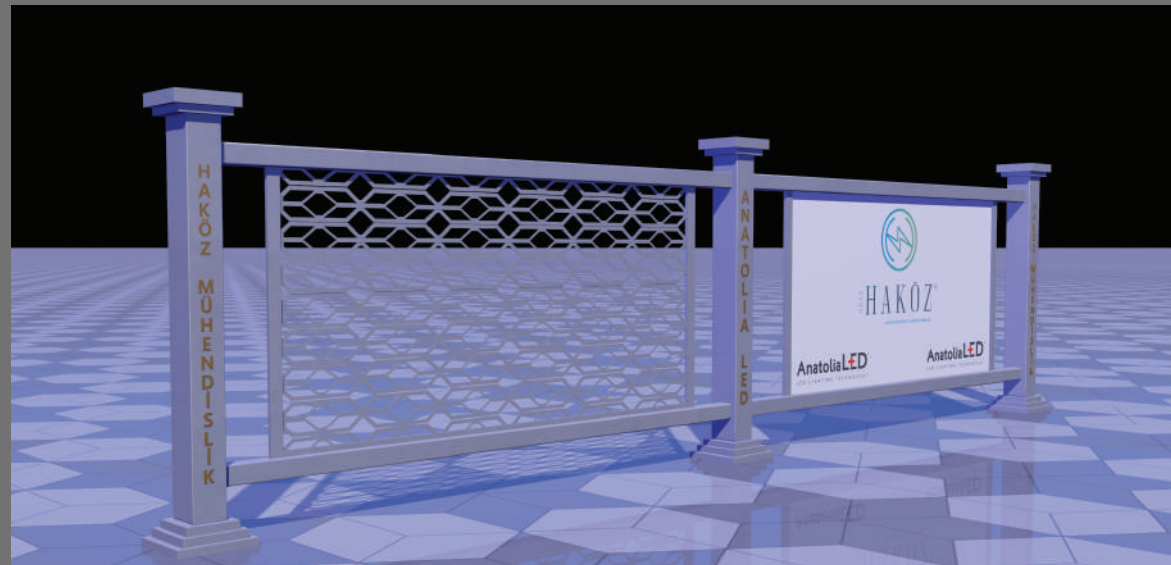

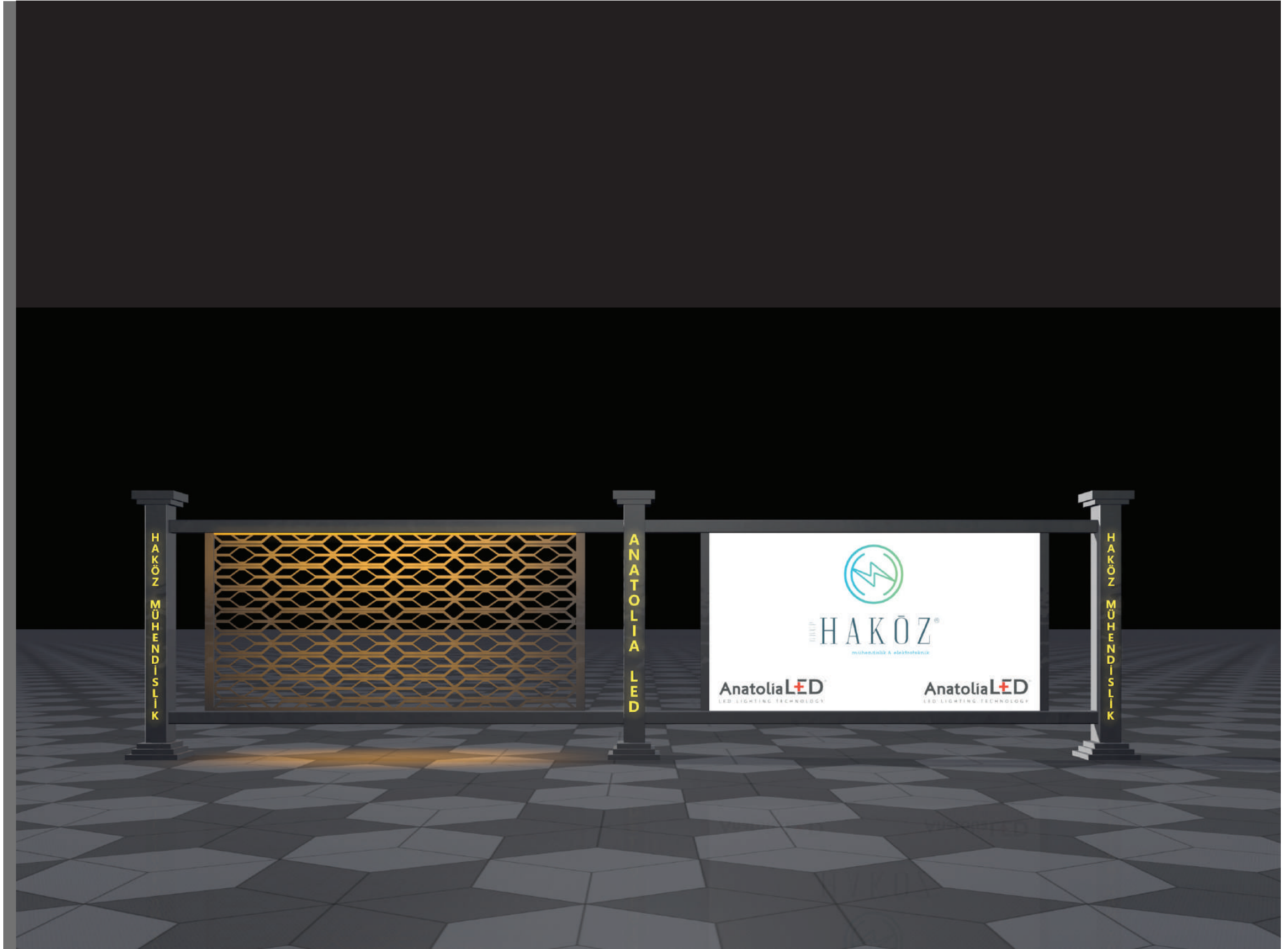

## YAYA TRAFİK İKAZ IŞIK SİSTEMLERİ





Tag  
Çalışmaları



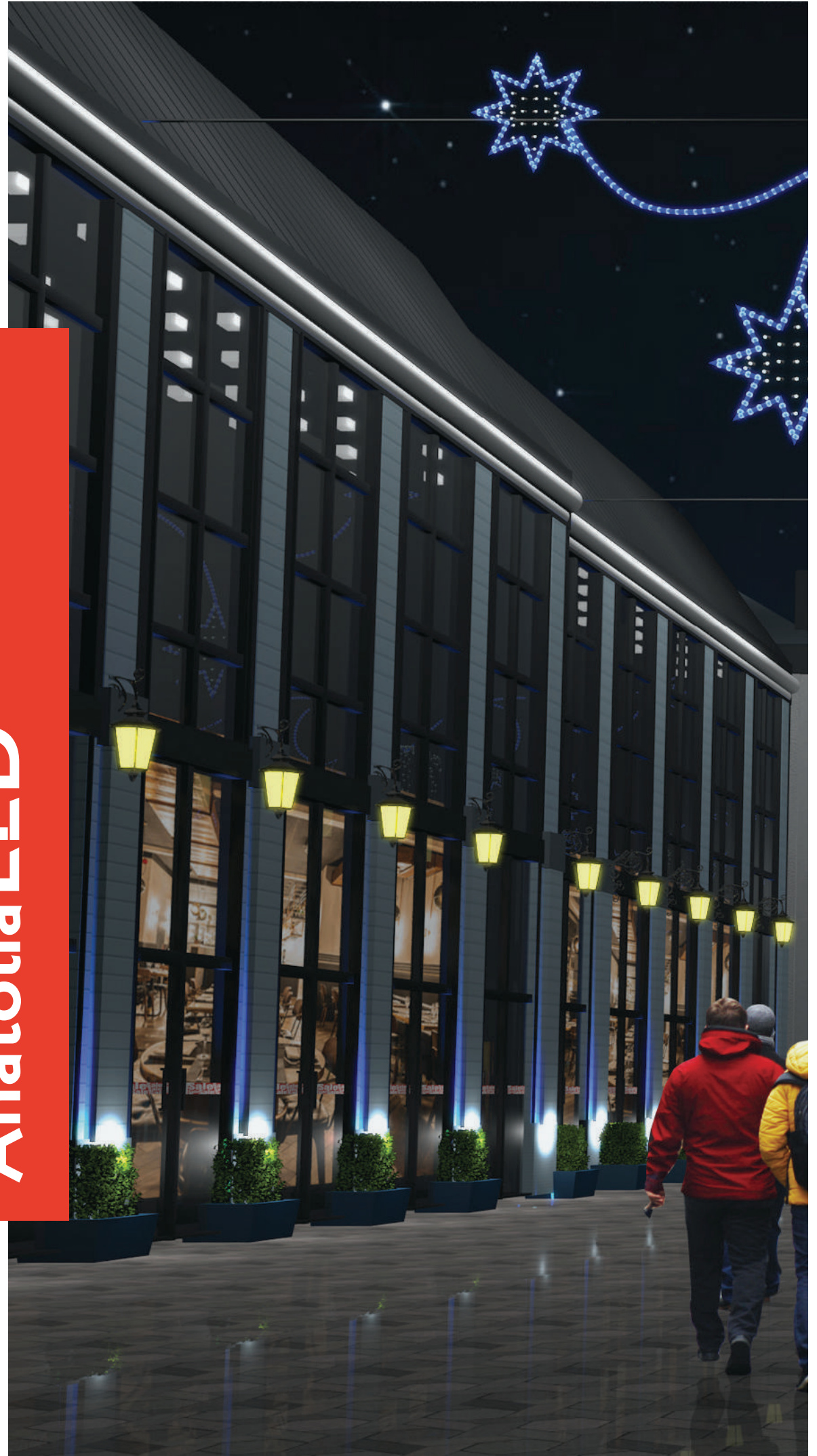

Tag  
Projects

Anatolia LED®



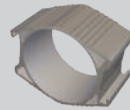
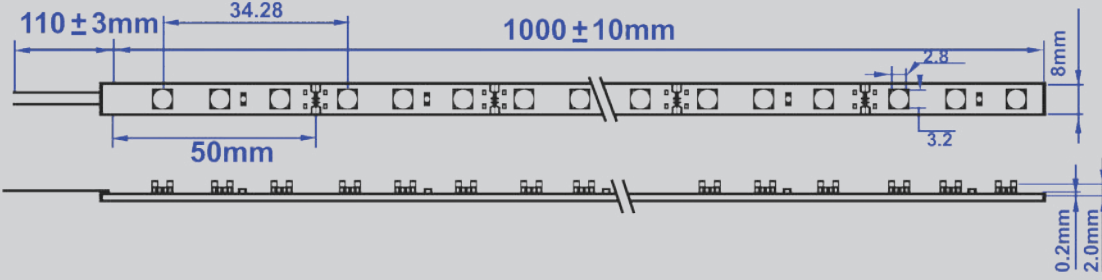





## ANATOLIA COOL

Profil Detayı Profile Detail	Gövde Body	Kaide Tipi Base Type	
	Alüminyum & Çelik Aluminium & Steel	Alüminyum & Çelik Aluminium & Steel	
Şerit Led Detayı Led Strip Detail			
			
Ürün Belgeleri Product Documents			
Ürün Sertifikaları Product Certificates	TS EN 605 98-1-2 TS EN 605 98-1 TS 8700 EN 605 98-2-3	ISO 9001:2008 ISO 14001:2004 ISO 18002	OHSAS 18001:2007

**AnatoliaLED®**  
LED LIGHTING TECHNOLOGY

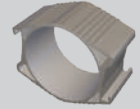
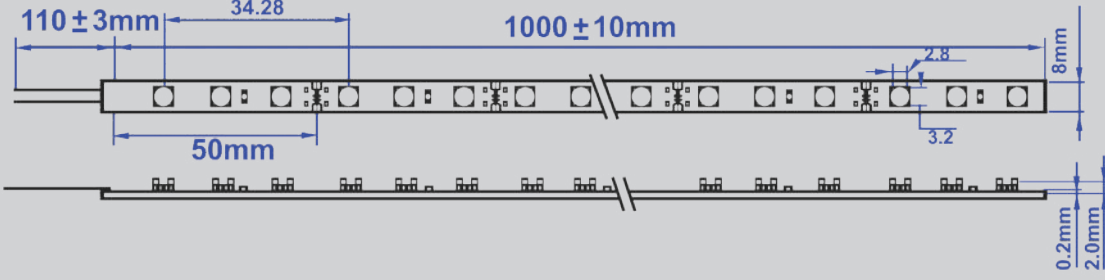





## ANATOLIA YILDIZ

Profil Detayı Profile Detail	Gövde Body	Kaide Tipi Base Type	
	Alüminyum & Çelik Aluminium & Steel	Alüminyum & Çelik Aluminium & Steel	
Şerit Led Detayı Led Strip Detail			
			
Ürün Belgeleri Product Documents			
Ürün Sertifikaları Product Certificates	TS EN 605 98-1-2 TS EN 605 98-1 TS 8700 EN 605 98-2-3	ISO 9001:2008 ISO 14001:2004 ISO 18002	OHSAS 18001:2007

**AnatoliaLED**  
LED LIGHTING TECHNOLOGY

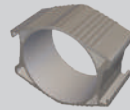
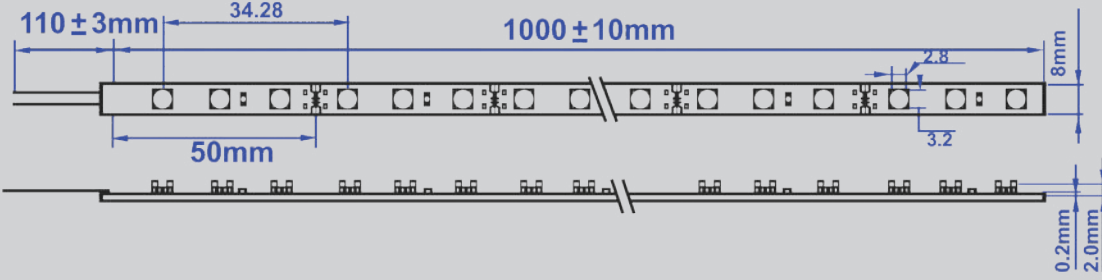

## ANATOLIA SATURN

Profil Detayı Profile Detail	Gövde Body	Kaide Tipi Base Type	
	Alüminyum & Çelik Aluminium & Steel	Alüminyum & Çelik Aluminium & Steel	
Şerit Led Detayı Led Strip Detail			
			
Ürün Belgeleri Product Documents			
Ürün Sertifikaları Product Certificates	TS EN 605 98-1-2 TS EN 605 98-1 TS 8700 EN 605 98-2-3	ISO 9001:2008 ISO 14001:2004 ISO 18002	OHSAS 18001:2007

**AnatoliaLED®**  
LED LIGHTING TECHNOLOGY



Şehir Tag  
Çalışmaları

City Tag  
Projects

Anatolia LED®

2019

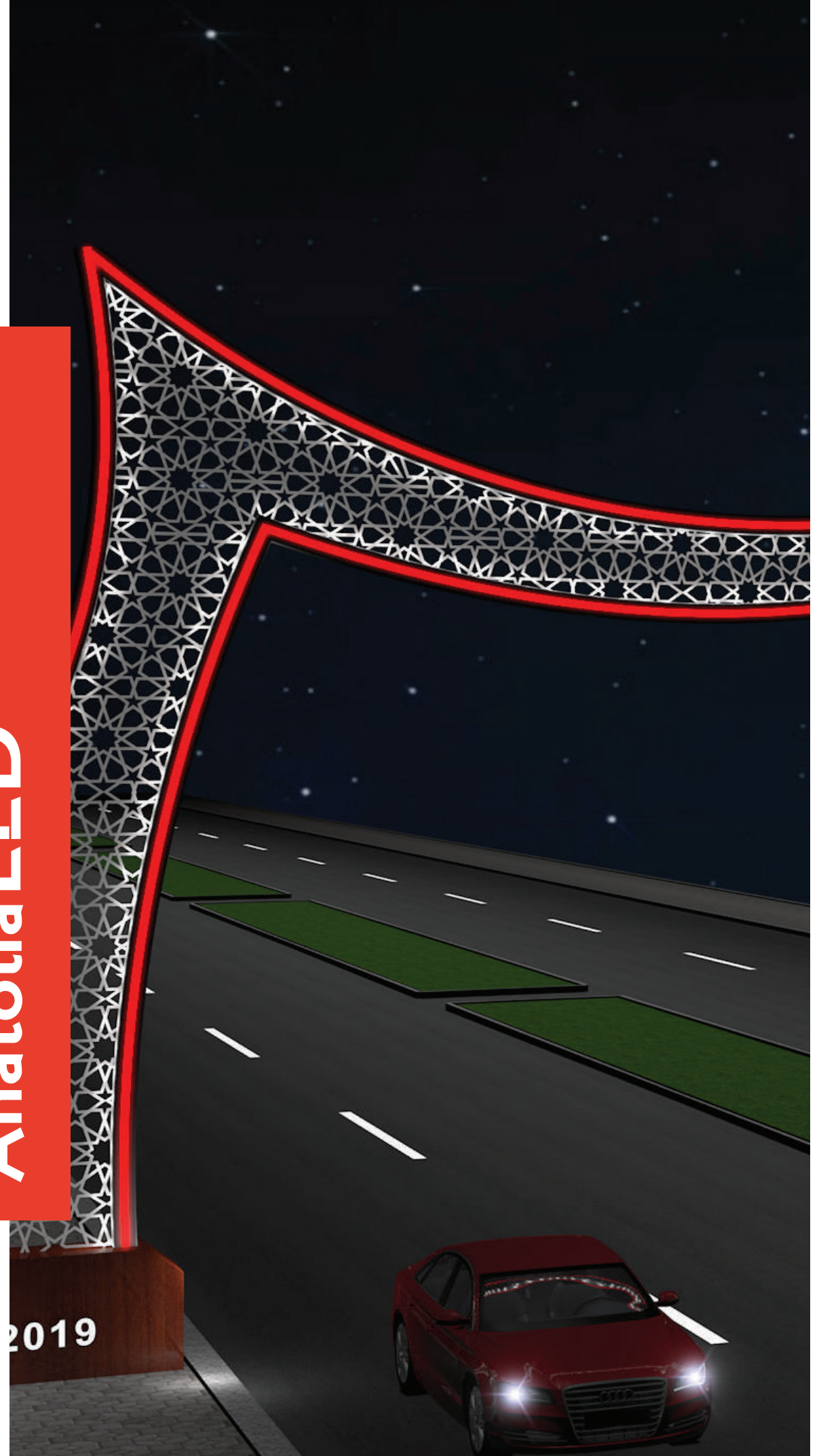



**ANATOLIA LED**  
LED LIGHTING TECHNOLOGY





**HAKÖZ**  
MÜHENDİSLİK

2019

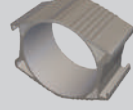
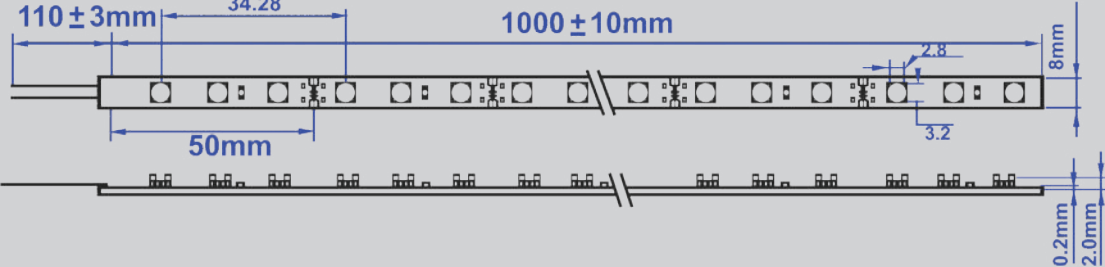
## ŞEHİR TAG I

Profil Detayı Profile Detail	Gövde Body	Kaide Tipi Base Type
	Alüminyum & Çelik Aluminium & Steel	Alüminyum & Çelik Aluminium & Steel
Şerit Led Detayı Led Strip Detail		
		



Ürün Belgeleri Product Documents			
Ürün Sertifikaları Product Certificates	TS EN 605 98-1-2 TS EN 605 98-1 TS 8700 EN 605 98-2-3	ISO 9001:2008 ISO 14001:2004 ISO 18002	OHSAS 18001:2007



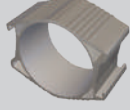
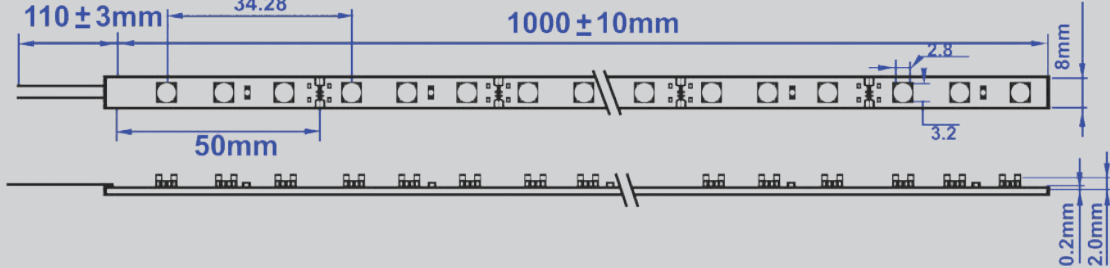

## ŞEHİR TAG II

Profil Detayı Profile Detail	Gövde Body	Kaide Tipi Base Type
	Alüminyum & Çelik Aluminium & Steel	Alüminyum & Çelik Aluminium & Steel
Şerit Led Detayı Led Strip Detail		
		

Ürün Belgeleri Product Documents			
Ürün Sertifikaları Product Certificates	TS EN 605 98-1-2 TS EN 605 98-1 TS 8700 EN 605 98-2-3	ISO 9001:2008 ISO 14001:2004 ISO 18002	OHSAS 18001:2007







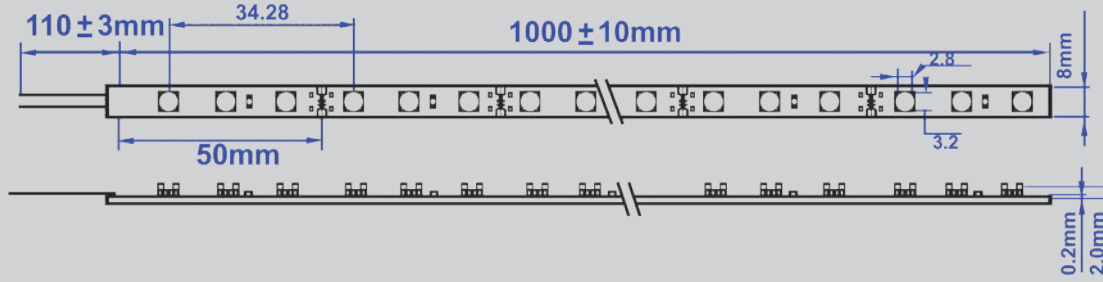

## ŞEHİR TAG III

Profil Detayı Profile Detail	Gövde Body	Kaide Tipi Base Type
	Alüminyum & Çelik Aluminium & Steel	Alüminyum & Çelik Aluminium & Steel

Şerit Led Detayı  
Led Strip Detail





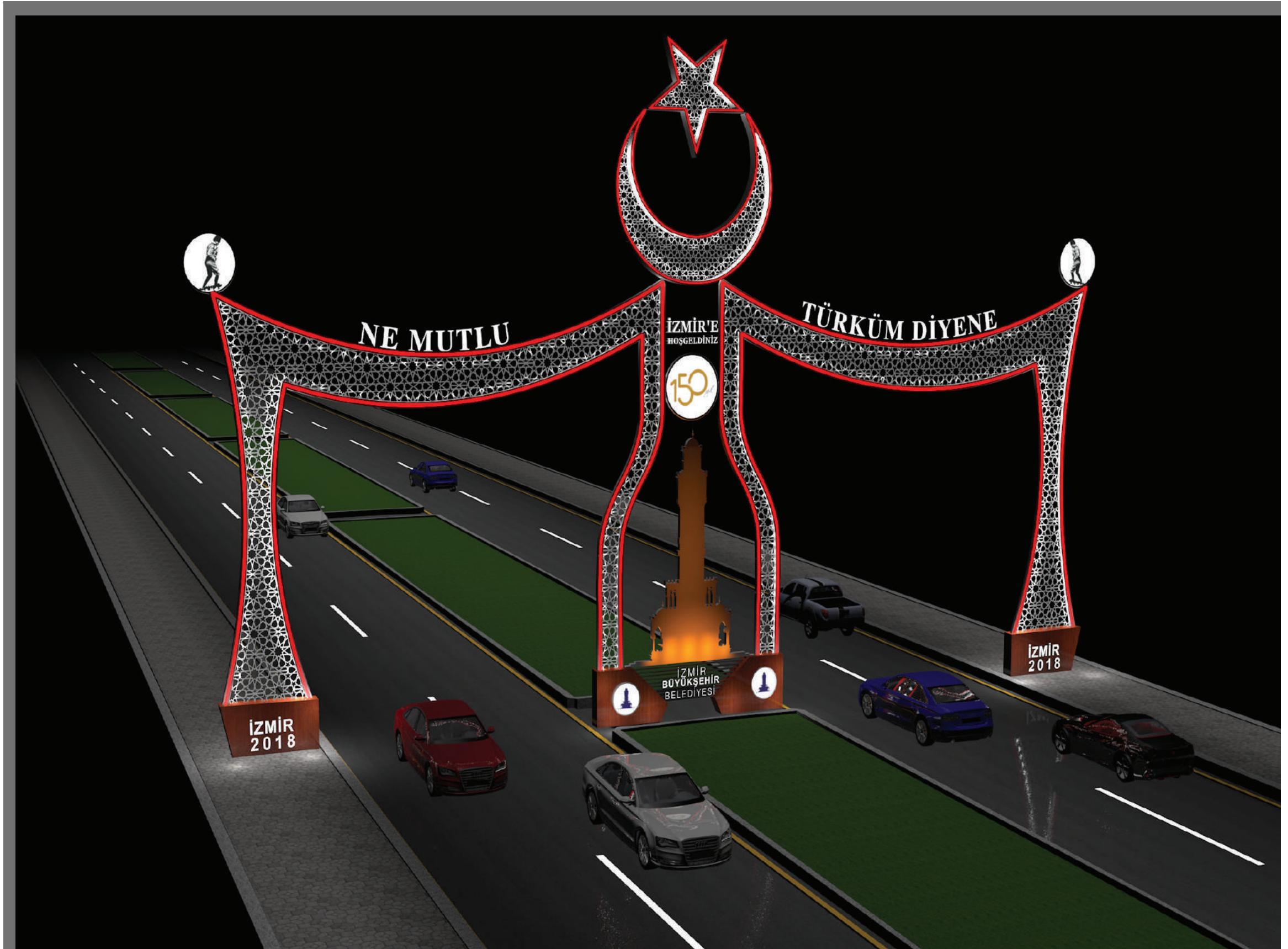

Ürün Belgeleri Product Documents			
Ürün Sertifikaları Product Certificates	TS EN 605 98-1-2 TS EN 605 98-1 TS 8700 EN 605 98-2-3	ISO 9001:2008 ISO 14001:2004 ISO 18002	OHSAS 18001:2007



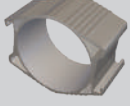
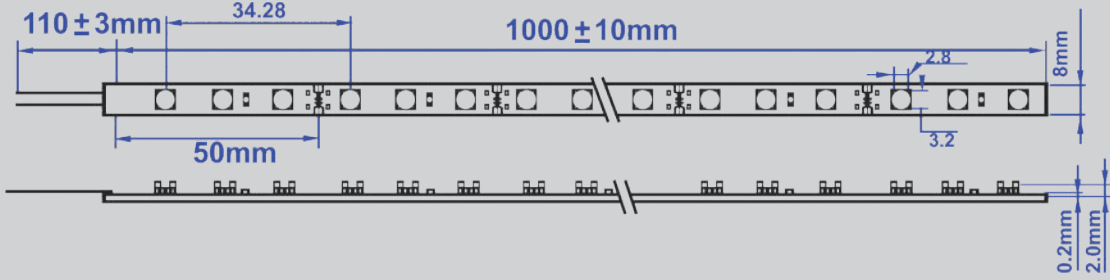

## ŞEHİR TAG IV

Profil Detayı Profile Detail	Gövde Body	Kaide Tipi Base Type	
	Alüminyum & Çelik Aluminium & Steel	Alüminyum & Çelik Aluminium & Steel	
Şerit Led Detayı Led Strip Detail			
			
Ürün Belgeleri Product Documents			
Ürün Sertifikaları Product Certificates	TS EN 605 98-1-2 TS EN 605 98-1 TS 8700 EN 605 98-2-3	ISO 9001:2008 ISO 14001:2004 ISO 18002	OHSAS 18001:2007





# Anatolia LED®

LED LIGHTING TECHNOLOGY

www.medyababa.com

**ADRES / ADDRESS:** Yavuz Sultan Mh. Hürriyet Cd.  
No:309/1-2-A Derince/KOCAELİ  
**FABRİKA / FACTORY:** Mimarsinan Mh. Mehmet Akif  
Ersoy Cd. No: 167 ABC Körfez/KOCAELİ  
**TEL:** +90 262 239 14 08  
**FAX:** +90 262 239 14 09  
**E-MAIL:** info@hako.com.tr  
**WEBSITE:** www.hako.com.tr

   @hako.com.tr

